

SYMPTOM CONTROL AND QOL COMMITTEE

CONTENTS

S1007 Phase III.....	7
S1013 Validation.....	10
S1200 Phase III.....	14
S1202 Phase III.....	18
S1207 Phase III.....	24
S1400I Phase III.....	26
S1404 Phase III.....	28
S1418 Phase III.....	30
A021202 Phase II SWOG Supported CTSU Study.....	32
A041202 Phase III SWOG Supported CTSU Study.....	34
B55 Phase III SWOG Supported CTSU Study.....	36
C30610 Phase III SWOG Supported CTSU Study.....	38
C51101 Phase II SWOG Supported CTSU Study.....	40
E1411 Phase II SWOG Supported CTSU Study.....	42
E1912 Phase III SWOG Supported CTSU Study.....	44
E1A11 Phase III SWOG Supported CTSU Study.....	46
E1Z11 Cohort SWOG Supported CTSU Study.....	48
E2810 Phase III SWOG Supported CTSU Study.....	50
E2906 Phase III SWOG Supported CTSU Study.....	52
E3A06 Phase III SWOG Supported CTSU Study.....	55
EA6134 Phase III SWOG Supported CTSU Study.....	57
N1048 Phase II/III SWOG Supported CTSU Study.....	59
R0848 Phase III SWOG Supported CTSU Study.....	61
R1112 Phase III SWOG Supported CTSU Study.....	63

Patient Registrations to Studies

By 12 Month Intervals
 SYMPTOM CONTROL AND QOL COMMITTEE

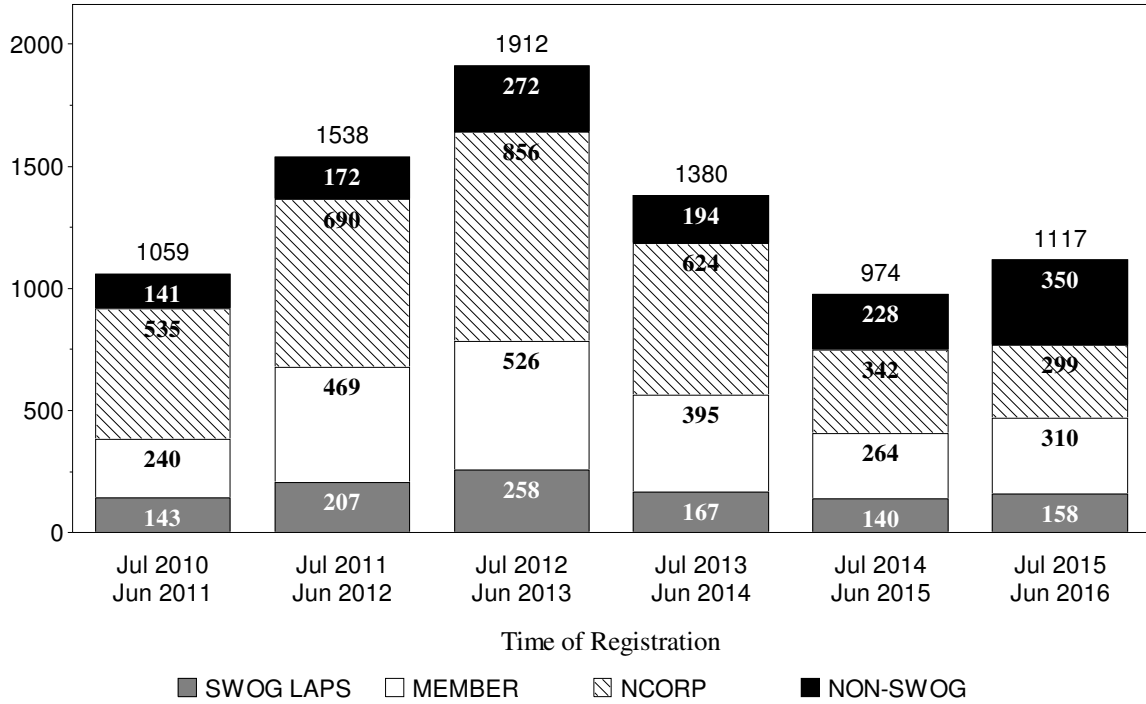

Screening registrations and registrations to Biologic only studies are excluded

Patient Registrations by Study and Arm

SYMPTOM CONTROL AND QOL COMMITTEE

	Jan 2016 Jun 2016	Jul 2015 Dec 2015	Jan 2015 Jun 2015	All Patients
S1013 Validation Study of FACT-EGFRI				
Initial registration				
EGFRI-induced skin-related tox	10	18	21	138
S1200 Breast, AI Joint Pain, Acupuncture				
Randomization				
Blinded Treatment/Waitlist Control	19	19	30	191
S1202 Duloxetine AI Joint Pain				
Randomization				
Blinded Drug	0	61	90	299
S1207 Brst, Adj, Endocrine+/-Everolimus				
Randomization				
Blinded drug + Endocrine	261	181	156	824
S1404 Melan, Adv, HD-IFN/Ipilimumab vs MK-3475				
Randomization				
FDA approved regimen	97	2	0	99
MK-3475 (Pembrolizumab)	95	2	0	97
	<u>192</u>	<u>4</u>	<u>0</u>	<u>196</u>
A011104 Preoperative Breast MRI*				
Total Registrations	0	1	0	3
A021202 Carcinoid, Pazopanib vs Placebo*				
Total Registrations	0	12	10	35
A041202 CLL, 65+, Ben+Rtx vs Ibrut±Rtx*				
Total Registrations	4	30	30	99
A091105 Desmoid, Sorafenib vs Placebo*				
Total Registrations	0	3	4	9
A221101 Glioma, Nuvigil/Placebo Fatigue*				
Total Registrations	3	3	1	13
A221102 Brst, AI Arthralgia, Testosterone*				
Total Registrations	3	0	1	4
B51 Breast, Regional Nodal XRT*				
Total Registrations	2	4	0	8
B52 Breast, Neoadj TCHP +/- AI*				
Total Registrations	3	2	3	9
B55 Brst, Adj Olaparib for BRCA, TNBC*				
Total Registrations	4	3	2	9
C30610 SCLC, Thoracic RT*				
Total Registrations	0	1	1	50

	Jan 2016 Jun 2016	Jul 2015 Dec 2015	Jan 2015 Jun 2015	All Patients
C51101 CNS, myelo/non-myelo chemo, PhII*				
Total Registrations	0	0	2	5
C90203 Pros, Surgery +/- Neoadj Chemo*				
Total Registrations	0	2	7	154
E1411 MCL, RB+R, RBV+R, RB+LR, RBV+LR*				
Total Registrations	9	18	17	82
E1912 CLL, Age 18-70, Ibrutinib vs FCR*				
Total Registrations	37	27	31	130
E1A11 MM, frontline, BLD vs CLD*				
Total Registrations	21	3	6	49
E1Z11 Brst, Genetic Predictors of AIMSS*				
Total Registrations	7	5	23	132
E2108 Early Local Tx for Int Prim Tum*				
Total Registrations	0	1	9	52
E2112 Brst, Adv, Exemestane+/-Entinostat*				
Total Registrations	8	7	1	16
E2511 SCLC, Ext, CDDP+Etoposide+Blind*				
Total Registrations	0	0	5	8
E2810 Renal, Pazopanib vs Placebo*				
Total Registrations	4	7	5	39
E3311 Oroph, Srg + Low or Std IMRT*				
Total Registrations	5	15	7	31
E3A06 AMM, Lenalidomide vs Observation*				
Total Registrations	1	6	5	29
E4112 Breast, MRI + DCIS Score*				
Total Registrations	8	12	0	20
EA6134 Adv, BRAF mut, D+T/Ipi+Niv vs Ipi+Niv/D+T*				
Total Registrations	5	2	0	7
G0286B Adv Endometrial, Metformin/Chemo*				
Total Registrations	0	0	1	1
N1048 Rectal, Local Adv, ChemoRT+/-FOLFOX*				
Total Registrations	17	8	15	86
N1174 Bev +/- TRC105 in Bev Naïve GBM*				
Total Registrations	0	1	0	2
NRGCC002 GYN, Pre/Post Op Eval in Elderly*				
Total Registrations	0	0	1	1
NRGHN001 Nasopharyngeal, Individual Tx EBV*				
Total Registrations	2	0	0	2

	Jan 2016 Jun 2016	Jul 2015 Dec 2015	Jan 2015 Jun 2015	All Patients
R0815 Pros, dose-esca. RT +/- ADT*				
Total Registrations	0	3	3	13
R0834 Anaplastic Glioma, CATNON trial*				
Total Registrations	0	0	1	1
R0848 Panc, Adj, Erlotinib v ChemoRT*				
Total Registrations	1	3	0	20
R0920 HN, Adv, Postop IMRT ± Cetuximab*				
Total Registrations	1	3	2	9
R0924 Pros, NADT+WPRT vs. NADT+P&SV RT*				
Total Registrations	11	4	1	20
R1216 HN, Adv, Cis vs Dtx vs Dtx+Cetux*				
Total Registrations	2	1	0	3
Z11102 Breast Conserv. Surgery for MIBC*				
Total Registrations	4	3	4	13

* For non-SWOG coordinated studies only SWOG registrations are shown.

S1007 Phase III

Coordinating Group: SWOG

A Phase III Randomized Clinical Trial of Standard Adjuvant Endocrine Therapy +/- Chemotherapy in Patients with 1-3 Positive Nodes, Hormone Receptor-Positive and HER2-Negative Breast Cancer with Recurrence Score (RS) of 25 or Less. RxPONDER: A Clinical Trial Rx for Positive Node, Endocrine Responsive Breast Cancer

Participants:

SWOG, CTSU (Supported by NRG, Alliance, ECOG-ACRIN, CCTG, GEICAM and UNICANCER)

Date Activated:

01/15/2011

Study Chairs:

K Kalinsky, J Gralow

Date Closed*:

10/01/2015

* Open to UNICANCER sites only

Statisticians:

W Barlow, D Lew, J Miao

Data Coordinators:

L Kaye, J Scurlock

SCHEMA

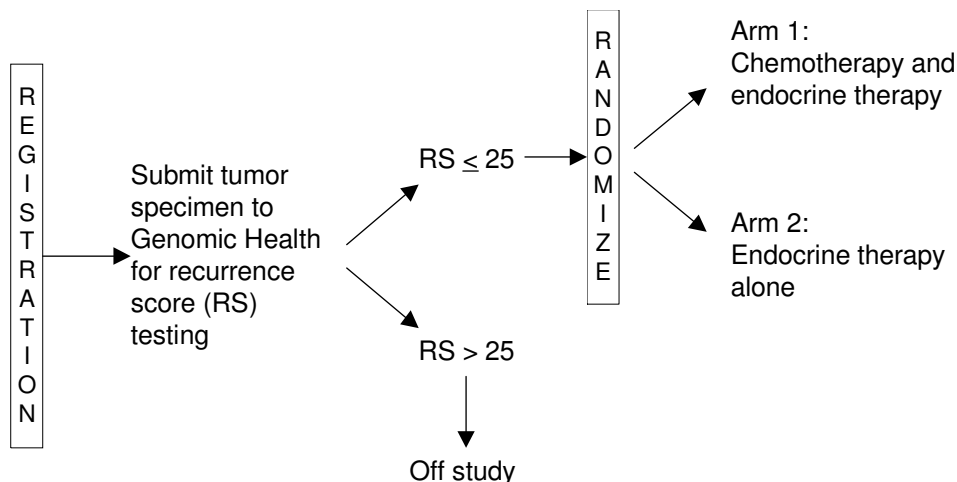

Objectives

To determine the effect of chemotherapy in patients with node-positive breast cancer who do not have high Recurrence Scores (RS) by Oncotype DX®. In

patients with 1-3 positive nodes, and hormone receptor (HR)-positive, HER2-negative breast cancer with $RS \leq 25$ treated with endocrine therapy we will test whether the difference in disease-free survival for

patients treated with chemotherapy compared to no chemotherapy depends directly on the magnitude of RS. If benefit depends on the RS score, the trial will determine the optimal cutpoint for recommending chemotherapy or not.

To compare overall survival (OS), distant disease-free survival (DDFS) and local disease-free interval (LDFI) by receipt of chemotherapy or not and its interaction with RS.

To compare the toxicity across the treatment arms.

To perform other assays or tests (in particular the PAM50 risk of relapse score), as they are developed and validated, that measure potential benefit of chemotherapy and compare them to Oncotype DX®.

To determine the impact of management with Oncotype DX® on patient-reported anxiety (co-primary Health-Related Quality of Life [HRQL] outcome) prior to screening, after disclosure of test results, and during the randomized trial.

To determine the impact of Oncotype DX® on the initial management cost of node-positive, HR-positive, HER2-negative breast cancer.

To compare patient-reported utilities (e.g. QOL) for those randomized to chemotherapy versus no chemotherapy.

Using modeling and DFS information from the trial, to estimate the cost-effectiveness of management with Oncotype DX® versus usual care.

To determine the role of other assays (e.g. PAM50) as predictors of DFS, DDFS and LDFI for patients randomized to chemotherapy versus no chemotherapy.

To determine the impact of treatment with chemotherapy versus no chemotherapy on patient-reported fatigue and cognitive concerns (secondary HRQL outcomes).

To determine the impact of management with Oncotype DX® on patient-reported decision conflict, perceptions regarding Oncotype DX® testing, and survivor concerns prior to screening, after disclosure of test results, and during the randomized trial (secondary HRQL outcomes).

Patient Population

Patients must be women with a histologically confirmed diagnosis of node-positive (1-3 nodes) invasive breast carcinoma with positive estrogen and/or progesterone receptor status, and negative HER-2 status. HER-2 test result negativity must be assessed as per ASCO/CAP 2013 guidelines using IHC, ISH or both. If HER-2 IHC is 2+, evaluation for gene amplification (ISH) must be performed and the ISH must be negative; ISH is not required if IHC is 0 or 1+. Patients with equivocal HER-2 are not eligible. Patients with multifocal, multicentric, and synchronous bilateral breast cancers are allowed. Patients must not have inflammatory breast cancer and must not have metastatic disease.

Patients must have had either breast-conserving surgery with planned radiation therapy or total mastectomy (with or without planned postmastectomy radiation). Patients must have clear margins from both invasive cancer and DCIS; LCIS at the margins is allowed. Patients must have undergone axillary staging by sentinel node biopsy or axillary lymph node dissection. Patients with positive sentinel node are not required to undergo full axillary lymph node dissection; this is at the discretion of the treating physician. Patients with micrometastases as the only nodal involvement (pN1mi) are not eligible. Patients must not have begun chemotherapy or endocrine therapy for their breast cancer prior to registration. Patients must be able to receive taxane and/or anthracycline based chemotherapy. Patients must not have received an aromatase inhibitor (AI) or a selective estrogen receptor modulator (SERM) such as tamoxifen or raloxifene within five years prior to registration. Partial breast irradiation (including brachytherapy) is not allowed. Radiation in the opposite breast is acceptable. Patients with a prior diagnosis of contralateral DCIS are eligible if they underwent a mastectomy or lumpectomy with whole breast radiation. Patients with a prior diagnosis of ipsilateral DCIS or invasive breast cancer who received radiation to that breast are not eligible.

Registration of patients who have not yet undergone Oncotype DX® screening must occur no later than 56 days after definitive surgery. For all patients, randomization (Step 2 Registration) must occur within 84 days after definitive surgery. If the Oncotype DX® Breast Cancer Assay has not been performed, patients must be willing to submit tissue samples directly to Genomic Health for testing to determine Recurrence Score value. If the Oncotype DX® Recurrence Score is already known and is 25 or less, the patient must be randomized (registered to

Step 2) immediately following initial registration. If the Oncotype DX® Recurrence Score is already known and is greater than 25, the patient is ineligible.

Patients must have a Zubrod performance status of 0-2 and must not require chronic treatment with systemic steroids (inhaled steroids are allowed) or other immunosuppressive agents.

Stratification/Descriptive Factors

Patient randomization will be stratified by the following factors: (1) Recurrence Score: 0-13 vs 14-25; (2) menopausal status: pre vs post; and (3) type of nodal dissection: axillary lymph node dissection (with or without sentinel node mapping) vs sentinel node biopsy without axillary lymph node dissection.

Accrual Goals

The accrual goal for the randomized trial is 4,000 eligible patients, which will require approximately 9,400 women to be screened for inclusion. An additional 1,000 eligible patients from UNICANCER in France will be randomized. Annual interim analyses are planned beginning when 24% of the events have been observed, approximately 6.6 years after initiation of the study.

Summary Statement

For the current status of this study, please refer to the Breast chapter.

S1013 Validation

A Prospective Study of Epidermal Growth Factor Receptor (HER-1/EGFR) Inhibitor-Induced Dermatologic Toxicity: Validation of the Functional Assessment of Cancer Therapy-EGFRI 18 (FACT-EGFRI 18) Questionnaire for EGFRI-Induced Skin Toxicities

Study Chairs:

S Wong, C Moinpour, J Wade

Date Activated:

11/15/2011

Statisticians:

J Unger, K Arnold

Data Coordinator:

J Patterson

Objectives

To establish psychometric properties for the Functional Assessment of Cancer Therapy Epidermal Growth Factor Receptor Inhibitor (FACT-EGFRI 18) module (based on criterion validity, known group's validity, internal consistency reliability, and responsiveness to change) as a patient-reported outcome (PRO) measure of EGFRI-induced skin-related toxicity.

To document minimally important differences over time for the FACT-EGFRI 18 by comparing mean changes in this PRO measure to the patient's direct assessment of change using two anchor items (change in skin condition severity and impact).

To examine the association between toxicity profiles (severity and time to onset), and treatment profiles (e.g., delays and discontinuation) and the FACT-EGFRI 18 scores.

To assess degree of concordance between FACT-EGFRI 18 ratings and study site physician CTCAE Version 4.0 EGFRI-Induced Dermatologic Toxicity Grading Assessment ratings.

To evaluate feasibility outcomes.

Patient Population

Patients must have a diagnosis of colorectal or lung

cancer and be planning to receive one of the following HER1/EGFR inhibitor therapies listed below for at least 6 weeks: (a) cetuximab 400 mg/m² loading dose, 250 mg/m² weekly; (b) cetuximab 500 mg/m² every 2 weeks; (c) panitumumab 6 mg/kg every 2 weeks; (d) erlotinib 100-150 mg daily. Other HER1/EGFR inhibitor therapies, schedules, or doses of the above listed agents are not allowed.

Concurrent chemotherapy and other anti-cancer therapies (such as carboplatin, paclitaxel, and bevacizumab) are allowed EXCEPT for the following chemotherapeutic agents which are known to cause skin rash that could interfere with EGFRI-induced skin toxicity assessment: gemcitabine, capecitabine, and topical fluorouracil. Patients may have had prior HER1/EGFR inhibitor therapy but must have fully recovered from any skin toxicities prior to registration. Patients must not have any of the serious concomitant skin disorders specified in the protocol that, in the investigator's opinion, could interfere with assessment of EGFRI induced skin toxicity. Patients must not be planning to receive any of the concomitant medications specified in the protocol that can cause skin rash or other dermatologic reactions that could interfere with the EGFRI-induced skin toxicity assessments, for the duration of the study. Patients must not be planning to receive concurrent external beam radiation therapy, including prophylactic cranial radiation.

Patients must have a Zubrod performance status of 0-2. Patients must be able to complete questionnaires in English. Patients may concurrently participate in other therapeutic clinical trials. Patients must be able to complete the baseline S1013 FACT-EGFRI 18 within three days prior to initiation of EGFRI therapy.

Accrual Goals

This study will enroll 156 patients.

Summary Statement

This study activated on November 15, 2011, to limited institutions. As of June 30, 2016, 138 participants have been registered.

One patient is ineligible due to a baseline Performance Status greater than 2. One patient who

received treatment prior to the baseline assessment, two patients who never received EGFRI treatment, and 14 patients who did not have a rash by 6 weeks are not analyzable. One hundred and eight patients are off protocol. Ten patients refused further follow-up, unrelated to an adverse event: three withdrew consent for further follow-up, three could not maintain the examination schedule at the site, two refused to complete further questionnaires, and two declined all further participation. Two patients are coded as off protocol due to "Other – not protocol specified": one received off-protocol radiation treatment and one patient was unable to return to clinic for the final assessment at Day 127.

Initial Registrations By 6 Month Intervals

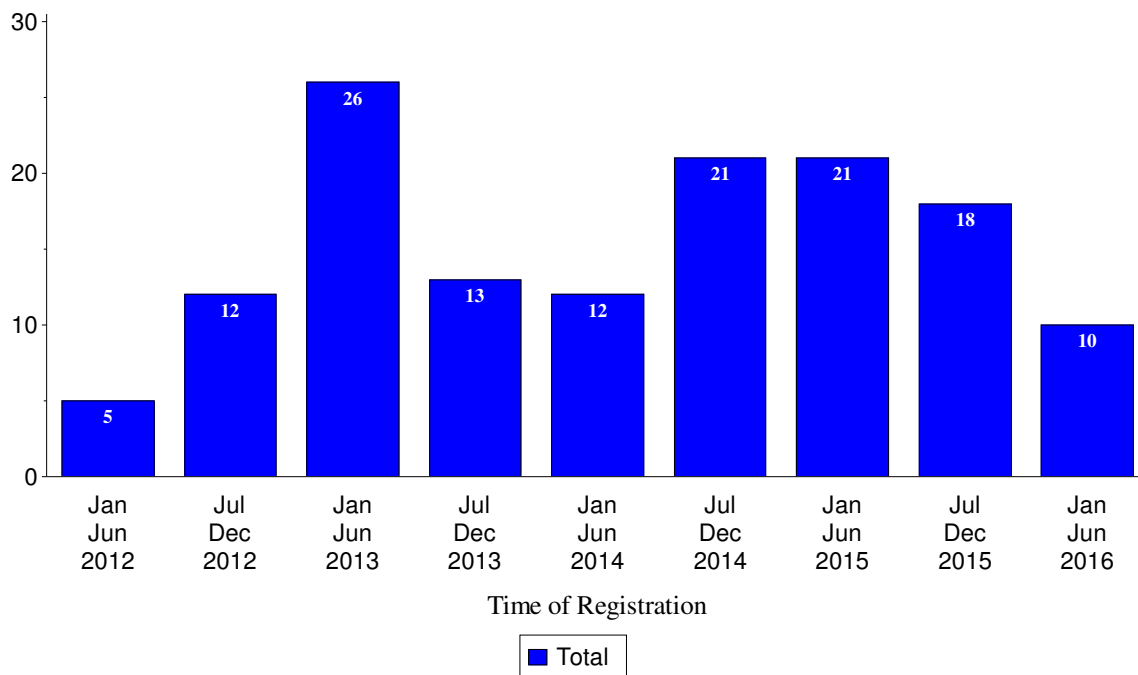

Registration by Institution
Registrations ending June 30, 2016

Institutions	Total Reg	Institutions	Total Reg
Heartland NCORP	59	LSU-Shreveport/Gulf South MU-NCORP	4
So Calif, U of	25	Columbia MU-NCORP	3
City of Hope Med Ctr	19	McLaren Cancer Inst/Wayne State Univ	3
Wichita NCORP	11	Kansas City NCORP	1
Gulf South MU-NCORP	7	Loma Linda Univ	1
Southeast COR NCORP	5	Total (11 Institutions)	138

Registration, Eligibility, and Evaluability

Registrations ending June 30, 2016; Data as of July 1, 2016

	Total
NUMBER REGISTERED	138
INELIGIBLE	1
ELIGIBLE	137
Analyzable, Pend. Elig.	1
Not Analyzable	17

Patient Characteristics

Registrations ending June 30, 2016; Data as of July 1, 2016

	Total (n=120)	
AGE		
Median	65.5	
Minimum	36.7	
Maximum	88.1	
SEX		
Males	60	50%
Females	60	50%
HISPANIC		
Yes	12	10%
No	107	89%
Unknown	1	1%
RACE		
White	105	88%
Black	3	2%
Asian	11	9%
Native American	1	1%

Treatment Summary

Registrations ending June 30, 2016; Data as of July 1, 2016

	Total
NUMBER ON PROTOCOL TREATMENT	12
NUMBER OFF PROTOCOL TREATMENT	108
REASON OFF TREATMENT	
Treatment completed as planned	68
Adverse Event or side effects	4
Refusal unrelated to adverse event	10
Progression/relapse	15
Death	8
Other - not protocol specified	2
Reason under review	1
MAJOR PROTOCOL DEVIATIONS	0

S1200 Phase III

Randomized Blinded Sham- and Waitlist-Controlled Trial of Acupuncture for Joint Symptoms Related to Aromatase Inhibitors in Women with Early Stage Breast Cancer

Study Chairs:

D Hershman, K Crew

Date Activated:

03/27/2012

Statisticians:

J Unger, D Lew

Data Coordinator:

R Topacio

SCHEMA

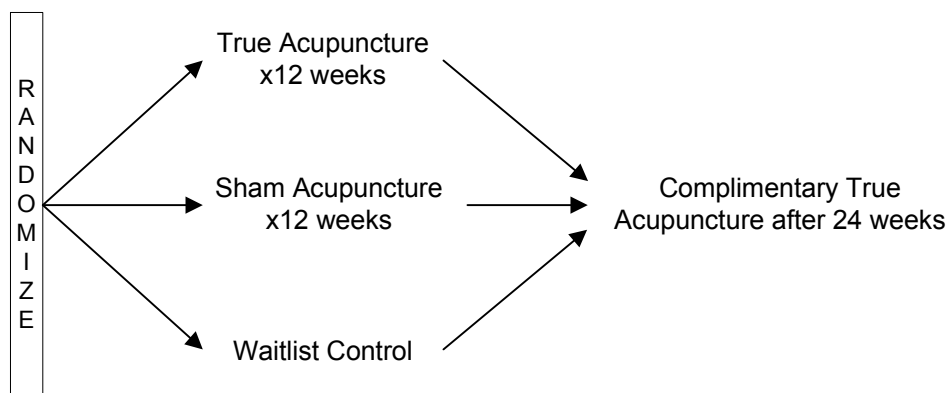
**Objectives**

To determine whether true acupuncture administered twice weekly for six weeks compared to sham acupuncture and waitlist control causes a significant reduction in joint pain related to aromatase inhibitors (AIs) in women with early stage breast cancer as measured by the Brief Pain Inventory-Short Form (BPI-SF) worst pain score at six weeks.

To evaluate the effects of acupuncture on the Brief Pain Inventory-Short Form (BPI-SF) worst pain, worst stiffness, pain severity, and pain-related interference scores.

To evaluate the effects of acupuncture on Western Ontario and McMaster Universities Osteoarthritis

(WOMAC) index (pain, stiffness, and function) for the hips and knees.

To evaluate the effects of acupuncture on Modified-Score for the Assessment and Quantification of Chronic Rheumatoid Affections of the Hands (M-SACRAH) (pain, stiffness, and function).

To evaluate the effects of acupuncture on the PROMIS Pain Impact-Short Form (PROMIS PI-SF).

To evaluate the effects of acupuncture on quality of life (QOL) as assessed by the Functional Assessment of Cancer Therapy-Endocrine Subscales (FACT-ES).

To evaluate the effects of acupuncture on functional testing with grip strength and "Timed Get Up and Go" (TGUG) test.

To evaluate the effects of acupuncture on analgesic and opioid use.

To evaluate the effects of acupuncture on self-reported AI adherence.

To assess AI adherence via urine AI metabolites.

To evaluate the effects of acupuncture on serum hormones (estradiol, FSH, LH) and inflammatory biomarkers (serum TNF α , IL-6, IL-12, CRP and urine CTX-II).

To evaluate whether polymorphisms in CYP19A1 aromatase gene predict severity of AI-related joint symptoms.

To assess the safety and tolerability of acupuncture in this study population.

Patient Population

Patients must be women with histologically confirmed primary invasive carcinoma of the breast (Stage I, II, or III) with no evidence of metastatic disease (M0), or with histologically confirmed DCIS. Patients must have ER and/or PgR positive disease.

If patient has undergone breast cancer surgery, she must have recovered from all side-effects of the surgery. Patients must currently be taking a third-generation aromatase inhibitor (anastrozole, letrozole, or exemestane) for at least the previous 30 days prior to registration, with plans to continue for at least an additional one year. Patients may have switched AIs provided that they have been on a stable dose for at least 30 days. Concurrent trastuzumab (Herceptin) is allowed.

Patients must have had two or fewer acupuncture treatments within the past 12 months for any reason except for joint symptoms. Patients must not have had prior acupuncture treatment for joint symptoms at any time. Patients must not be on narcotics or have received topical analgesics to the study joint or any other analgesics with the exception of NSAIDs and acetaminophen within 14 days prior to registration. Patients must not have received oral corticosteroids, intramuscular corticosteroids, or intra-articular steroids for joint symptoms within 28 days prior to registrations. Patients must not have received or

implemented any other medical therapy, alternative therapy, or physical therapy for the treatment of joint pain/stiffness within 28 days prior to registration. Therapeutic massage is allowed. Patients must not have a history of bone fracture or surgery of the afflicted knees and/or hands within six months prior to registration.

Patients must be post-menopausal as defined in the protocol and have a Zubrod performance status of 0-1. Patients must have completed the S1200 Brief Pain Inventory - Short Form within 14 days prior to registration and have a worst pain score of at least 3 that has started or increased since starting AI therapy. Patients must not have a severe bleeding disorder, an allergy to latex, or concurrent medical/arthritis disease that could confound or interfere with evaluation of pain or efficacy. Patients must be willing to submit blood and urine for correlative analyses as specified in the protocol. Patients must be able to complete study questionnaires in English or Spanish.

Stratification/Descriptive Factors

Patients will be randomized using a 2:1:1 ratio to true acupuncture vs. sham acupuncture vs. waitlist control. Patient randomization will be dynamically balanced according to study site at time of registration.

Accrual Goals

A total of 228 patients will be enrolled to achieve 208 eligible patients.

Summary Statement

This study opened to accrual on March 27, 2012, and is open to limited institutions. As of June 30, 2016, there have been 191 registrations. Five patients who did not complete the Brief Pain Inventory within 14 days prior to registration are ineligible. Major deviations are coded for one patient who received the incorrect acupuncture treatment for two sessions when a different acupuncturist was covering her appointments, four patients who were randomized to acupuncture but received no treatment, and one patient who was randomized to waitlist but was in too much pain to wait for treatment. One patient was removed from protocol treatment for non-compliance.

No Grade 3 or higher adverse events have been reported.

Registration by Institution

Registrations ending June 30, 2016

Institutions	Total Reg	Institutions	Total Reg
CRC West MI NCORP	53	Fred Hutchinson CRC	9
Kaiser Perm NCORP	52	Good Samaritan Hosp/Oregon Hlth Sci Univ	8
Columbia MU-NCORP	23	So Calif, U of	3
Greenville NCORP	14	Utah, U of	3
St Luke's Mt State/PCRC NCORP	14	PCRC NCORP	2
Lahey Hosp & Med Ctr	10	Total (11 Institutions)	191

Registration, Eligibility, and Evaluability

Registrations ending June 30, 2016; Data as of July 12, 2016

	Total
NUMBER REGISTERED	191
INELIGIBLE	5
Insufficient Documentation	5
Irreversible	5
ELIGIBLE	186
Analyzable, Pend. Elig.	2
ADVERSE EVENT ASSESSMENT	
Evaluable	129
Not Evaluable	5
Too Early	2
Not Applicable	50

Patient Characteristics

Registrations ending June 30, 2016; Data as of July 12, 2016

	Total (n=186)	
AGE		
Median	60.8	
Minimum	27.1	
Maximum	79.3	
HISPANIC		
Yes	14	8%
No	172	92%
RACE		
White	164	88%
Black	7	4%
Asian	12	6%
Native American	1	1%
Unknown	2	1%

Treatment Summary

Registrations ending June 30, 2016; Data as of July 12, 2016

	Total
NUMBER ON PROTOCOL TREATMENT	28
NUMBER OFF PROTOCOL TREATMENT	158
REASON OFF TREATMENT	
Treatment completed as planned	136
Adverse Event or side effects	0
Refusal unrelated to adverse event	19
Progression/relapse	2
Death	0
Other - not protocol specified	1
Reason under review	0
MAJOR PROTOCOL DEVIATIONS	6

Number of Patients with a Given Type and Grade of Adverse Event

Adverse Events Unlikely or Not Related to Treatment Excluded

Registrations ending June 30, 2016; Data as of July 12, 2016

	Total (n=129) Grade					
ADVERSE EVENTS	0	1	2	3	4	5
Arthralgia	64	44	21	0	0	0
Back pain	127	2	0	0	0	0
Bruising	77	52	0	0	0	0
Dizziness	125	4	0	0	0	0
Ear pain	128	1	0	0	0	0
Edema limbs	127	2	0	0	0	0
Hematoma	128	1	0	0	0	0
Hot flashes	128	0	1	0	0	0
Inj/poisoning/proced comp-Oth	125	4	0	0	0	0
Myalgia	127	2	0	0	0	0
Nausea	128	1	0	0	0	0
Pain	124	5	0	0	0	0
Pain in extremity	128	1	0	0	0	0
Peripheral sensory neuropathy	128	1	0	0	0	0
Presyncope	127	0	2	0	0	0
ROM decreased	123	5	1	0	0	0
MAX. GRADE ANY ADVERSE EVENT	40	66	23	0	0	0

S1202 Phase III

A Randomized Placebo-Controlled Phase III Study of Duloxetine for Treatment of Aromatase Inhibitor-Associated Musculoskeletal Symptoms in Women with Early Stage Breast Cancer

Study Chairs:

N Henry, A Schott

Date Activated:

05/15/2013

Statisticians:

J Unger, D Lew, A Moseley

Date Closed:

10/01/2015

Data Coordinator:

R Topacio

SCHEMA

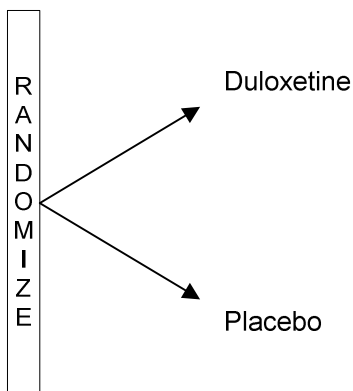
**Objectives**

To assess whether daily duloxetine decreases average joint pain in women with aromatase inhibitor-associated musculoskeletal syndrome (AIMSS), as measured at 12 weeks by the modified Brief Pain Inventory Short Form (BPI-SF).

To assess whether daily duloxetine decreases worst joint pain in women with AIMSS, as measured at 12 weeks by the modified BPI-SF.

To assess whether daily duloxetine decreases pain interference in women with AIMSS, as measured at 12 weeks by the modified BPI-SF.

Patient Population

Patients must be women with histologically confirmed ER and/or PgR positive invasive carcinoma of the breast with no evidence of metastatic disease (M0).

Patients must have completed mastectomy or breast sparing surgery and have recovered from all side-effects of the surgery. Any chemotherapy and/or radiation therapy must be completed at least 28 days prior to registration, and patients must have recovered from all Grade 2 or higher side effects with the exception of alopecia and peripheral neuropathy. Concurrent bisphosphonate and trastuzumab therapies are allowed. Patients must currently be taking one of the following aromatase inhibitor (AI) doses for at least 21 days with plans to continue for at

least an additional 180 days after registration: anastrozole 1 mg daily, letrozole 2.5 mg daily, or exemestane 25 mg daily. Patients may have received any number of prior AI therapies, but the first AI therapy must have started no more than 36 months prior to registration. Patients must not have previously taken the serotonin norepinephrine reuptake inhibitors (SNRI) duloxetine or milnacipran. Patients must not require selective serotonin reuptake inhibitors (SSRIs) or tricyclic antidepressants during study participation. Prior venlafaxine is allowed as long as it was not taken for treatment of pain (e.g., prior treatment for hot flashes is permitted). Patients must not take MAO-inhibitors for 14 days before registration or any time during study treatment. Concomitant therapy with heparin and warfarin is also not permitted at registration or while on protocol treatment. Aspirin is permitted.

Patients must be post-menopausal as defined in the protocol and have adequate renal and hepatic function and a Zubrod performance status of 0-2. Patients must have AI associated musculoskeletal symptoms that began or increased after starting AI therapy. New musculoskeletal pain must not be due specifically to fracture or traumatic injury. Patients must have completed the S1202 Brief Pain Inventory - Short Form within 7 days prior to registration and have an average pain score of at least 4 (BPI-SF item #4). Patients must have no known allergy or hypersensitivity to duloxetine or any of the inactive ingredients in the matching placebo. Patients must not have any contraindicated concurrent illnesses or be taking any contraindicated medications listed on the duloxetine package insert including anticoagulation medicine. Patients must not have concurrent medical/arthritis disease that could confound or interfere with evaluation of pain or efficacy. Patients who are receiving treatment with narcotics, tramadol, gabapentin, and/or pregabalin must have been taking a stable dose for at least 30 days prior to registration. Patients must be willing to submit blood samples for correlative analyses as specified in the protocol. Patients must be able to complete study questionnaires in English or Spanish.

Stratification/Descriptive Factors

Patient randomization will be dynamically balanced according to the following stratification factors: (1) baseline pain score (BPI-SF item #4): 4-6 vs 7-10; and (2) prior taxane use: yes vs no.

Accrual Goals

A total of 294 patients will be enrolled to achieve 270 eligible patients.

Summary Statement

This study was activated on May 15, 2013, and closed on October 1, 2015, after meeting its accrual goal. There were 299 patients registered.

Sixteen patients are ineligible for the following reasons: eight due to failure to complete the BPI-SF within 7 days prior to registration, three due to AI therapy started more than 36 months prior to registration, two due to prior venlafaxine taken for pain, two due to not meeting the protocol definition of post-menopausal, and one due to unacceptable baseline creatinine clearance. A major deviation is recorded for 15 other patients: four who received only one day of intervention, nine who did not receive any protocol intervention and are therefore not evaluable for adverse events, one who did not begin protocol intervention until over a month after registration, and one who changed AI and was not removed from protocol intervention. Four patients were removed from protocol treatment for reasons other than adverse events, patient refusal, or progression: one due to non-compliance, one due to no longer experiencing pain after registration, one due to change of AI therapy after registration, and one due to concurrent venlafaxine. These four patients did not receive any protocol intervention and are among those recorded as major deviations.

Sixteen patients have experienced Grade 3 toxicities among 273 patients assessed for adverse events, including 5 cases of Grade 3 insomnia. There have been no Grade 4 or 5 toxicities reported.

Registration by Institution
Registrations ending June 30, 2016

Institutions	Total Reg	Institutions	Total Reg
NRG	44	Beaumont NCORP	2
Alliance	43	Kansas City NCORP	2
Kaiser Perm NCORP	40	Michigan, U of	2
ECOG-ACRIN	23	MUSC MU-NCORP	2
Southeast COR NCORP	17	PCRC NCORP	2
Gulf South MU-NCORP	15	Porter Memorial Hosp/Loyola University	2
Wichita NCORP	13	Schumpert St Mary/San Antonio, U of TX	2
Heartland NCORP	11	Texas Tech Univ HSC/San Antonio, U of TX	2
Sacred Heart Hosp/Arkansas, U of	10	Columbia MU-NCORP	1
Michigan CRC NCORP	9	Columbus NCORP	1
Dayton NCORP	6	Greenville NCORP	1
Intermountain MC/Northwest NCORP	5	Highline Medical Ctr/Franciscan Res Ctr	1
Montana NCORP	5	Loyola University	1
Tulane University	5	McLaren Cancer Inst/Wayne State Univ	1
Prov Portland MC/PCRC NCORP	4	Nevada CRF NCORP	1
Cedars-Sinai Med Ctr	3	New Mexico MU-NCORP	1
Hawaii MU-NCORP	3	Northwest NCORP	1
LSU-Shreveport/Gulf South MU-NCORP	3	Ozarks NCORP	1
PIH Health Hosp/Irvine, U of CA	3	S Georgia Med Ctr/Brooke Army Med Ctr	1
Sutter Cancer RC	3	Tulane Univ MBCCOP	1
Wayne State Univ	3	Watson Clinic Center/H Lee Moffitt CC	1
Baptist MU-NCORP	2	Total (43 Institutions)	299

Registration, Eligibility, and Evaluability

Registrations ending June 30, 2016; Data as of July 7, 2016

	Total
NUMBER REGISTERED	299
INELIGIBLE	16
ELIGIBLE	283
 ADVERSE EVENT ASSESSMENT	
Evaluable	273
Not Evaluable	9
Too Early	1

Patient Characteristics

All eligible and selected ineligible patients included
Registrations ending June 30, 2016; Data as of July 7, 2016

	Total (n=283)	
AGE		
Median	60.3	
Minimum	27.4	
Maximum	83.4	
HISPANIC		
Yes	11	4%
No	271	96%
Unknown	1	0%
RACE		
White	242	86%
Black	27	10%
Asian	9	3%
Pacific Islander	1	0%
Native American	2	1%
Multi-Racial	1	0%
Unknown	1	0%
BASELINE PAIN SCORE		
4-6	213	75%
7-10	70	25%
PRIOR TAXANE USE		
Yes	152	54%
No	131	46%

Treatment Summary

All eligible and selected ineligible patients included
Registrations ending June 30, 2016; Data as of July 7, 2016

	Total	
NUMBER ON PROTOCOL TREATMENT	0	
NUMBER OFF PROTOCOL TREATMENT	283	
REASON OFF TREATMENT		
Treatment completed as planned	211	
Adverse Event or side effects	41	
Refusal unrelated to adverse event	24	
Progression/relapse	2	
Death	0	
Other - not protocol specified	4	
Reason under review	1	
MAJOR PROTOCOL DEVIATIONS	15	

Number of Patients with a Given Type and Grade of Adverse Event

Adverse Events Unlikely or Not Related to Treatment Excluded

All Eligible and Selected Ineligible Patients Included

Registrations ending June 30, 2016; Data as of July 7, 2016

ADVERSE EVENTS	Total (n=273) Grade					
	0	1	2	3	4	5
Abdominal pain	263	7	2	1	0	0
Agitation	261	10	2	0	0	0
Akathisia	272	1	0	0	0	0
Alkaline phosphatase increased	272	1	0	0	0	0
Anorectal infection	272	1	0	0	0	0
Anorexia	258	12	3	0	0	0
Anorgasmia	270	2	1	0	0	0
Anxiety	268	5	0	0	0	0
Arthralgia	246	12	13	2	0	0
Back pain	268	2	3	0	0	0
Bloating	272	1	0	0	0	0
Blurred vision	265	7	1	0	0	0
Bone pain	272	0	1	0	0	0
Chills	269	4	0	0	0	0
Concentration impairment	268	1	4	0	0	0
Constipation	249	18	6	0	0	0
Cough	265	8	0	0	0	0
DLOC	272	0	1	0	0	0
Delayed orgasm	272	1	0	0	0	0
Depression	267	2	4	0	0	0
Diarrhea	250	19	3	1	0	0
Dizziness	252	16	5	0	0	0
Dry eye	272	1	0	0	0	0
Dry mouth	221	50	2	0	0	0
Dysgeusia	271	2	0	0	0	0
Dyspepsia	266	6	1	0	0	0
Dyspnea	272	1	0	0	0	0
Eye disorders - Other, specify	272	1	0	0	0	0
Fatigue	211	42	19	1	0	0
Flashing lights	272	1	0	0	0	0
Flatulence	267	5	1	0	0	0
Floaters	272	1	0	0	0	0
Flu like symptoms	266	6	1	0	0	0
Flushing	272	1	0	0	0	0
Gen disorders/admin site cond	272	1	0	0	0	0
Headache	228	37	7	1	0	0
Hot flashes	241	24	8	0	0	0
Hyperhidrosis	259	10	4	0	0	0
Hypersomnia	272	0	0	1	0	0
Insomnia	247	11	10	5	0	0
Irritability	272	1	0	0	0	0
Lethargy	266	2	5	0	0	0
Libido decreased	267	6	0	0	0	0
MS/connective tissue disorder	271	0	2	0	0	0
Memory impairment	272	1	0	0	0	0

ADVERSE EVENTS	Total (n=273) Grade					
	0	1	2	3	4	5
Muscle weakness upper limb	271	2	0	0	0	0
Myalgia	242	16	14	1	0	0
Nasal congestion	266	7	0	0	0	0
Nausea	222	42	8	1	0	0
Neck pain	272	1	0	0	0	0
Nervous sys disorders-Other	270	2	1	0	0	0
Pain	254	8	11	0	0	0
Pain in extremity	267	2	2	2	0	0
Paresthesia	266	6	1	0	0	0
Pruritus	271	2	0	0	0	0
Psych disorders-Other, spec	269	4	0	0	0	0
ROM decreased	256	10	6	1	0	0
Rash acneiform	272	1	0	0	0	0
Rash maculo-papular	271	2	0	0	0	0
Restlessness	270	2	1	0	0	0
Somnolence	257	9	7	0	0	0
Spasticity	271	1	1	0	0	0
Tremor	264	8	1	0	0	0
Vertigo	261	9	3	0	0	0
Vomiting	268	2	2	1	0	0
Weight gain	269	4	0	0	0	0
MAX. GRADE ANY ADVERSE EVENT	99	84	74	16	0	0

S1207 Phase III

Coordinating Groups: SWOG and NRG

Phase III Randomized, Placebo-Controlled Clinical Trial Evaluating the Use of Adjuvant Endocrine Therapy +/- One Year of Everolimus in Patients with High-Risk, Hormone Receptor-Positive and Her2/neu Negative Breast Cancer. E3 Breast Cancer Study - Evaluating Everolimus with Endocrine therapy

Participants:

SWOG, NRG, CTSU

Date Activated:

09/03/2013

Study Chairs:

M Chavez MacGregor, P Ganz (NRG), L Pusztai, P Rastogi (NRG)

Statisticians:

W Barlow, J Miao, D Lew

Data Coordinator:

I Syquia

SCHEMA

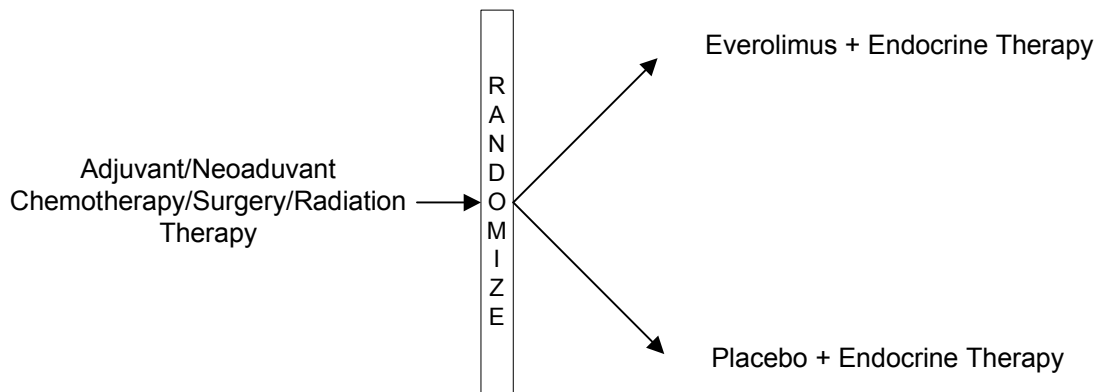

Objectives

To compare whether the addition of one year of everolimus (10 mg daily) to standard adjuvant endocrine therapy improves invasive disease-free survival (IDFS) in patients with high-risk, hormone-receptor (HR) positive and HER2-negative breast cancer.

To compare whether the addition of one year of everolimus to standard adjuvant endocrine therapy improves overall survival (OS) and distant recurrence-free survival (DRFS) in this patient population.

To evaluate the safety, toxicities, and tolerability of one year of everolimus in combination with standard adjuvant endocrine therapy and compare it with standard adjuvant endocrine therapy plus placebo in this patient population.

To determine whether the benefit of one year of everolimus use in addition to standard adjuvant endocrine therapy varies by recurrence score (RS), nodal status, or other commonly used prognostic factors.

Patient Population

Patients must have histologically confirmed invasive breast carcinoma with positive ER and/or PgR status and negative HER-2, for whom standard adjuvant endocrine therapy is planned. Patients must not have metastatic breast cancer. Patients with multifocal, multicentric, synchronous bilateral, and primary inflammatory breast cancers are allowed. Patients must be high risk as defined in the protocol, based on Recurrence Score and grade, number of positive nodes, and prior therapy. Patients with micrometastases as the only nodal involvement (pN1mi) are eligible, and will be categorized as node-negative.

Patients must have completed either breast-conserving surgery or total mastectomy with negative margins and appropriate axillary staging. Patients must have completed appropriate radiation therapy as described in the protocol. Patients must have completed standard neoadjuvant or adjuvant taxane and/or anthracycline based chemotherapy prior to

randomization. Patients may have started endocrine therapy at any time after the diagnosis of the current breast cancer. Patients must not be receiving or planning to receive trastuzumab. Concurrent bisphosphonate therapy is allowed. Patients must not have prior exposure to mTOR inhibitors.

Patients must have a Zubrod performance status of 0-2 and adequate hematologic, hepatic, renal, and cardiac function. Patients must not have received immunization with an attenuated live vaccine within seven days prior to registration. Patients must be able to take oral medications. Patients at NCORP institutions must be offered the opportunity to participate in the Behavioral and Health Outcomes (BAHO) substudy.

Stratification/Descriptive Factors

Patient randomization will be stratified by risk level as described in the protocol based on Recurrence Score and grade, number of positive nodes, and prior therapy.

Accrual Goals

The accrual goal is 1,900 patients. Interim analyses are planned for after approximately 40%, 60%, and 80% of the events in the control arm have been observed.

Summary Statement

For the current status of this study, please refer to the Breast chapter.

S1400I Phase III

Coordinating Group: SWOG

A Phase III Randomized Study of Nivolumab Plus Ipilimumab versus Nivolumab for Previously Treated Patients with Stage IV Squamous Cell Lung Cancer and No Matching Biomarker (LUNG-MAP Sub-Study)

Participants:
SWOG, CTSU

Date Activated:
12/18/2015

Study Chairs:
S Gettinger, L Bazhenova

Statisticians:
M Redman, K Griffin, J Miao, J Moon

Project Managers:
S Basse

Data Coordinators:
L Highleyman, K Amber

SCHEMA

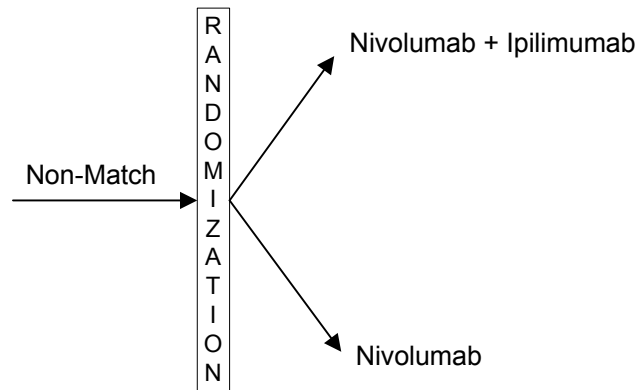

Objectives

To compare overall survival (OS) in patients with advanced stage refractory SCCA of the lung randomized to nivolumab plus ipilimumab versus nivolumab.

To compare investigator-assessed progression-free survival (IA-PFS) in patients with advanced stage

refractory SCCA of the lung randomized to receive nivolumab plus ipilimumab versus nivolumab.

To compare the response rates (confirmed and unconfirmed, complete and partial) per RECIST 1.1 among patients randomized to receive nivolumab plus ipilimumab versus nivolumab.

To compare the response rates (confirmed only, complete and partial) per RECIST 1.1 among patients randomized to receive nivolumab plus ipilimumab versus nivolumab.

To evaluate the frequency and severity of toxicities associated with nivolumab plus ipilimumab versus nivolumab.

To evaluate if there is a differential treatment effect on OS, IA-PFS, and Response by tumor PD-L1 expression status.

To examine patient reported outcomes by treatment arm.

Patient Population

Patients must have been eligible for the S1400 screening study and must have been assigned to the S1400I sub-study based on biomarker profiling results. Patients must have measurable disease by CT or MRI per RECIST 1.1. Patients must have a CT or MRI scan of the brain to evaluate for CNS disease. Patients must not have leptomeningeal disease, spinal cord compression, or brain metastases unless both (1) metastases have been locally treated and have remained clinically controlled and asymptomatic for at least 14 days following treatment, and (2) patient has no residual neurological dysfunction and has been off corticosteroids for at least one day prior to registration to S1400I.

Patients must not have received any prior systemic chemotherapy or investigational drug within 21 days prior to S1400I registration. Patients must not have received any radiation therapy within 14 days prior to

S1400I registration. Patients must not have had prior treatment with an anti-PD-1, anti-PD-L1, anti-PD-L2, anti-CTLA-4 antibody, or any other antibody or drug specifically targeting T-cell costimulation or immune checkpoint pathways. Patients must not have received systemic treatment with either corticosteroids or other immunosuppressive medications within 14 days prior to registration to S1400I.

Patients must have Zubrod performance status of 0-1 and adequate hematologic, hepatic, cardiac, and renal function. Patients must not have an active, known, or suspected autoimmune disease. Patients must not have a known positive test for HIV, AIDS, hepatitis B, or hepatitis C. Patients with a positive hepatitis C antibody with a negative viral load are allowed. Patients must not have interstitial lung disease that is symptomatic or may interfere with the detection or management of suspected drug-related pulmonary toxicity.

Stratification/Descriptive Factors

Treatment randomization will be stratified by the following: (1) gender: male vs female; (2) number of prior therapies: one vs two or more.

Accrual Goals

The accrual goal is 332 eligible patients. Interim analyses will be performed when 50% and 75% of the expected deaths have been observed.

Summary Statement

For the current status of this study, please refer to the Lung chapter.

S1404 Phase III

Coordinating Group: SWOG

A Phase III Randomized Trial Comparing Physician/Patient Choice of Either High Dose Interferon or Ipilimumab to MK-3475 (Pembrolizumab) in Patients with High Risk Resected Melanoma

Participants:

SWOG, CTSU (Supported by CCTG, ECOG-ACRIN)

Date Activated:

10/15/2015

Study Chairs:

K Grossmann, S Patel, A Tarhini (ECOG-ACRIN), T Petrella (CCTG)

Statisticians:

M Othus, H Li, J Moon

Data Coordinators:

D Heaney, J Barrett

SCHEMA

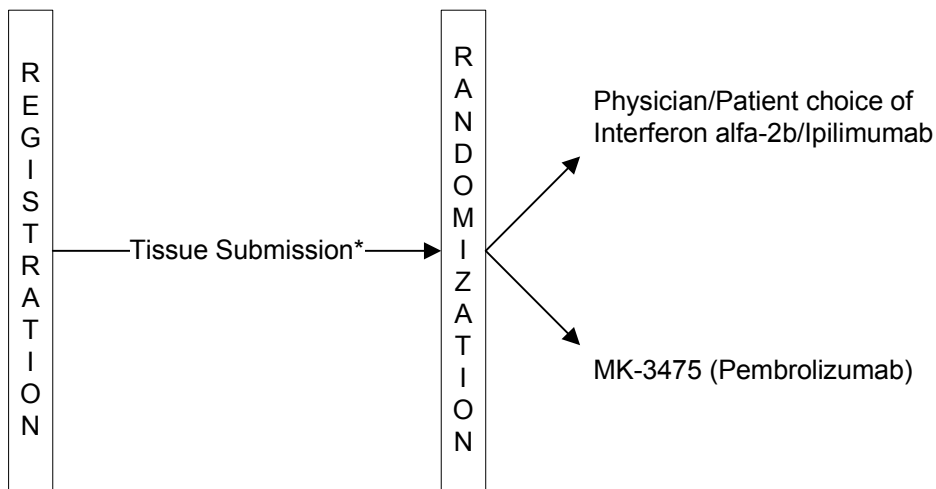

*PD-L1 status determined by central laboratory and blinded to the investigator and patient

Objectives

Co-Primary Objectives:

To compare overall survival (OS) of patients with resected Stage III and IV melanoma treated with

physician/patient choice of either high dose interferon alfa-2b or ipilimumab versus MK-3475 (pembrolizumab).

To compare OS of patients with resected Stage III and IV melanoma treated with physician/patient choice of either high dose interferon alfa-2b or ipilimumab versus MK-3475 (pembrolizumab) among patients who are PD-L1 positive.

To compare relapse-free survival (RFS) of patients with resected Stage III and IV melanoma treated with physician/patient choice of either high dose interferon alfa-2b or ipilimumab versus MK-3475 (pembrolizumab).

To compare RFS of patients with resected Stage III and IV melanoma treated with physician/patient choice of either high dose interferon alfa-2b or ipilimumab versus MK-3475 (pembrolizumab) among patients who are PD-L1 positive.

Secondary Objectives:

To estimate OS and RFS for patients who are PD-L1 negative or PD-L1 indeterminate in this population.

To compare OS and RFS between the two arms within the PD-L1 positive and PD-L1 negative subgroups and to investigate the interaction between PD-L1 status (positive versus negative) and treatment arm.

To assess the safety and tolerability of the regimens.

Patient Population

Patients must have histologically confirmed selected Stage III (IIIA/N2a, IIIB, IIIC) or Stage IV melanoma of cutaneous or mucosal origin or unknown primary. Patients must not have melanoma of ocular origin. Patients are eligible for this trial either at initial presentation of their melanoma, at time of first detected nodal, satellite/in-transit, distant metastases, or recurrent disease in prior lymphadenectomy basin or distant site. Patients must not have a history of brain metastases. Patients who have multiple regional nodal basin involvement are eligible. Gross or microscopic extracapsular nodal extension is permitted. All disease must have been completely resected with negative pathologic margins and no clinical, radiologic, or pathologic evidence of any incompletely resected melanoma. Patients must have available and be willing to submit adequate tissue for PD-L1 testing.

Patients may have received prior radiotherapy, including after the surgical resection that rendered the patient disease-free. Patients must not have received neoadjuvant treatment for their melanoma. Patients must not have received prior immunotherapy, including but not limited to ipilimumab, interferon alfa-2b, pegylated interferon, high dose IL-2, anti-PD-1, anti-PD-L1 intra-tumoral or vaccine therapies. Patients must be registered within 98 days of the last surgery performed to render the patient free of disease.

Patients must have a Zubrod performance status of 0-1, and have adequate renal, hepatic, hematologic, and cardiac function. Patients must not have active autoimmune disease that has required systemic treatment in the past two years. Patients must not have an active infection requiring systemic therapy. Patients must not have pneumonitis or a history of non-infectious pneumonitis that required steroids. Patients known to be HIV positive must have adequate CD4 counts and low viral load. Patients must not have known active hepatitis B or C infections. Patients must not have received live vaccines within 42 days prior to enrollment. Women of childbearing potential must have a negative pregnancy test within 28 days prior to randomization.

Stratification/Descriptive Factors

Treatment randomization will be stratified by the following: (1) surgically resected AJCC stage: IIIA(N2a) vs IIIB vs IIIC vs IV; (2) PD-L1 status: positive vs negative vs indeterminate; (3) planned control arm regimen: high dose interferon vs ipilimumab.

Accrual Goals

The accrual goal of this study is to randomize 1,240 eligible patients. Up to two formal interim analyses of overall survival will be performed when 55% and 85% of the expected deaths across both arms combined have been observed. There will be no interim analyses of relapse-free survival (RFS) and the final analysis of RFS is expected to be one year after the last eligible patients is randomized.

Summary Statement

For the current status of this study, please refer to the Melanoma chapter.

S1418 Phase III

Coordinating Groups: SWOG and NRG

A Randomized, Phase III Trial to Evaluate the Efficacy and Safety of MK-3475 (Pembrolizumab) as Adjuvant Therapy for Triple Receptor-Negative Breast Cancer with ≥ 1 cm Residual Invasive Cancer or Positive Lymph Nodes (ypN+) after Neoadjuvant Chemotherapy

Participants:

SWOG, NRG, CTSU

Study Chairs:

L Pusztai, J Mammen, P Ganz (NRG)

Statisticians:

W Barlow, D Lew, J Miao

Data Coordinator:

I Syquia

SCHEMA

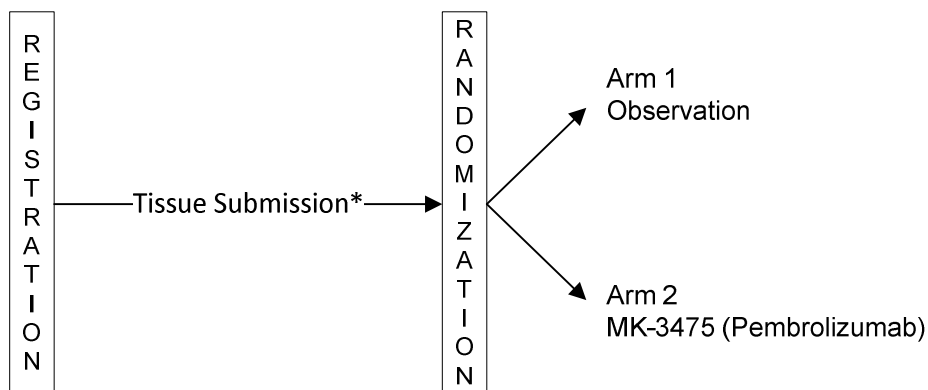

*PD-L1 status determined by central laboratory

Objectives

To compare invasive disease-free survival (IDFS) of patients with triple-negative breast cancer (TNBC) who have either ≥ 1 cm residual invasive breast cancer and/or positive lymph nodes ($>ypN+$) after neoadjuvant chemotherapy randomized to 1 year of

MK-3475 (pembrolizumab) adjuvant therapy compared to no MK-3475 (pembrolizumab), in both the entire study population and also in the PD-L1 positive subset.

To compare the effects of MK-3475 (pembrolizumab) on overall survival (OS) and distant recurrence-free survival (DRFS) between the two randomized arms for the PD-L1 positive patients and then all patients.

To assess the toxicity and tolerability of MK-3475 (pembrolizumab) in this patient population with or without radiation therapy.

To examine the association between biomarkers of inflammation and quality of life and patient reported outcomes between the two groups during and shortly after the end of therapy.

To examine the long-term and late effects of treatment on patient-reported outcomes.

Patient Population

Patients must have histologically confirmed ER-, PR- and HER2-negative breast cancer (triple-negative, TNBC) with residual invasive disease after completion of neoadjuvant chemotherapy. Residual disease must be ≥ 1 cm in greatest dimension, and/or have positive lymph nodes (ypN+) determined as described in the protocol. Patients must not have metastatic disease. Patients must have adequate tumor tissue for PD-L1 testing.

Patients must have received neoadjuvant chemotherapy which should include 12-24 weeks of a third generation chemotherapy regimen as recommended by NCCN guidelines for TNBC. Patients may receive post-operative (adjuvant) chemotherapy for up to 24 weeks, which must be given prior to any radiation and must have been completed within 35 days prior to registration. Patients must have completed their final breast surgery with clear resection margins for invasive cancer and DCIS within 210 days or 90 days (if no adjuvant chemotherapy) prior to registration. Patients may receive concomitant radiation therapy (XRT) or XRT prior to registration; the intention to use XRT and the extent of intended XRT must be specified at

registration if it has not been initiated. Patients must not have had prior immunotherapy with anti PD-L1 or anti-CTLA4 or similar drugs.

Patients must be at least 18 years of age, have a Zubrod performance status of 0-2, and must not have received live vaccines within 30 days prior to registration. Patients must not be HIV positive or have known active hepatitis B or C. Patients must not have active autoimmune disease that has required systemic treatment in the past two years, non-infectious pneumonitis, or an active infection requiring systemic therapy. Patients who speak/read English or Spanish must agree to participate in the BAHO substudy.

Patients must be registered to Step 2 for randomization within seven days of receiving e-mail notification that the patient's tissue specimen was adequate for PD-L1 testing. Patients must have adequate hematologic, hepatic, renal and thyroid function prior to randomization.

Stratification/Descriptive Factors

Randomization will be stratified by the following factors: (1) nodal stage: ypN0 vs ypN+; (2) residual tumor size: ≤ 20 mm vs > 20 mm; (3) PD-L1 status: positive vs negative; and (4) prior use of post-operative (adjuvant) chemotherapy: yes vs no.

Accrual Goals

The accrual goal is 1,000 patients to achieve 910 eligible patients. Two interim analyses will be performed when approximately 50% and 75% of the IDFS events in the PD-L1 positive population have been observed.

Summary Statement

For the current status of this study, please refer to the Breast chapter.

A021202 Phase II SWOG Supported CTSU Study

Coordinating Group: Alliance

Prospective Randomized Phase II Trial of Pazopanib (NSC #737754, IND #75648) Versus Placebo in Patients with Progressive Carcinoid Tumors

Participants:
Alliance, CTSU

Date Activated:
06/21/2013

Study Chairs:
E Bergsland (Alliance), A Phan (SWOG)

SCHEMA



Objectives

To compare centrally reviewed progression-free survival (PFS) between patients with progressive carcinoid tumors randomized to treatment with pazopanib versus placebo.

To compare overall survival between treatment arms.

To compare objective response rate, duration of response, and time to treatment failure between treatment arms.

To compare PFS as assessed by central radiology review and local radiology review overall and within treatment arms.

To estimate PFS at 6 months and 12 months within each treatment arm.

To evaluate safety and tolerability of treatment with pazopanib/placebo.

To compare biochemical response between treatment arms among patients with elevated baseline levels of CGA and 5-HIAA.

To assess differences in QOL-related domains between the two treatment groups.

To determine if the more brief measures of QOL-related domains provide comparable information to that which is provided by the longer assessments.

To provide validation data for the EORTC NET21 module in terms of responsiveness over time and differences across arms.

Patient Population

Patients must have low- or intermediate-grade neuroendocrine carcinoma, including the following subtypes: carcinoid tumor, low- to intermediate-grade or well- to moderately-differentiated neuroendocrine carcinoma or tumor, or atypical carcinoid tumor. Patients must have locally unresectable or metastatic carcinoid tumors arising in the foregut, midgut, hindgut, or other non-pancreatic site. Patients must have radiological evidence for progressive disease within 12 months prior to registration. Patients must have measurable disease per RECIST 1.1. Patients with tumors arising in the midgut must have progressed on octreotide. Patients must not have known endobronchial lesions and/or lesions infiltrating major pulmonary vessels that increase the risk of pulmonary hemorrhage. Patients must not have clinical evidence of brain metastases or carcinomatous meningitis.

Patients must not have received prior treatment with an inhibitor of VEGF or VEGFR. Treatment with strong inhibitors of CYP3A4 must be discontinued 14 days prior to start of study treatment. Other prior treatment must be completed at least four weeks prior to registration, and any treatment-related toxicities must have improved to Grade 1 or lower. Prior treatment with embolization or ablative therapies is allowed if measurable disease remains outside of the treated area or there is documented disease

progression in a treated site. Patients should have completed any major surgery at least four weeks prior to registration and must have completed any minor surgery at least two weeks prior to registration.

Patients must be at least 18 years of age and have ECOG performance status of 0-1. Patients must have adequate cardiac, hematologic, hepatic, renal, immunologic, and clotting function. Patients with symptomatic peripheral vascular disease are not eligible.

Stratification/Descriptive Factors

Patients are stratified by (1) site of primary: small bowel (defined as tumors arising in the small bowel, cecum, appendix, or unknown primary site) vs other; and (2) concurrent somatostatin analog: yes vs no.

Accrual Goals

The accrual goal for this study is 150 patients. Interim analyses for futility will be conducted when 38% and 75% of the expected number of events have been observed.

Summary Statement

For the current status of this study, please refer to the Gastrointestinal chapter.

A041202 Phase III SWOG Supported CTSU Study

Coordinating Group: Alliance

A Randomized Phase III Study of Bendamustine plus Rituximab Versus Ibrutinib plus Rituximab Versus Ibrutinib Alone In Untreated Older Patients (≥ 65 Years of Age) With Chronic Lymphocytic Leukemia (CLL)

Participants:
Alliance, CTSU

Date Activated:
12/10/2013

Study Chairs:
J Woyach (Alliance), S Coutre (SWOG)

Date Closed:
12/28/2015

SCHEMA

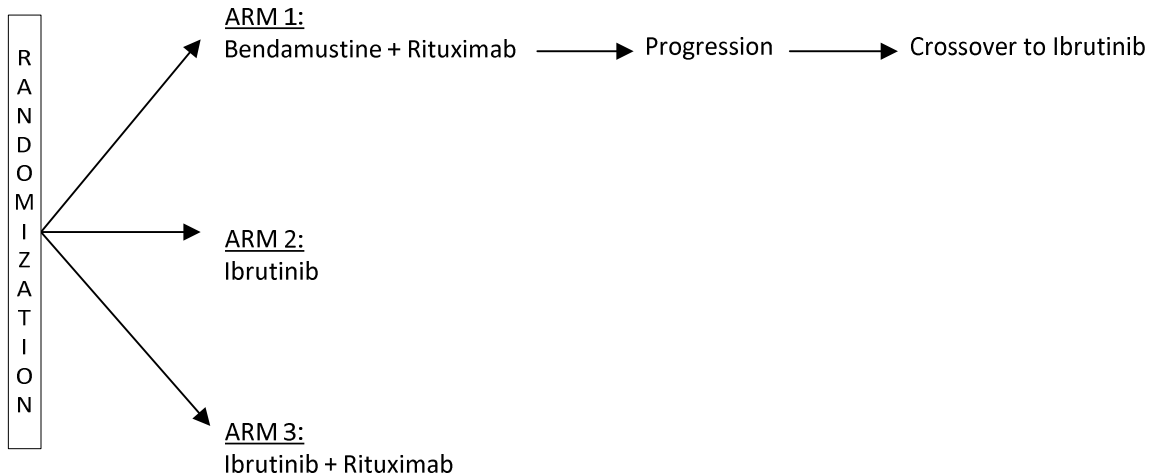

Objectives

To determine whether progression free survival (PFS) is superior after therapy with bendamustine in combination with rituximab, ibrutinib alone, or ibrutinib in combination with rituximab in patients age 65 or older with previously untreated CLL.

To determine 2-year PFS in each of the three treatment arms.

To determine which treatment arm produces superior overall survival (OS).

To determine the complete response (CR) rate, complete and nodular partial response (CR/nPR) rate,

and overall response (PR+nPR+CR) rate (ORR) among the three treatment arms and compare these arms.

To determine the impact of MRD-negative disease at time of CR documentation and at 2 years on PFS and OS in each of the treatment arms.

To determine duration of response after each of the three treatments and compare these treatment arms.

To determine toxicity and tolerability of the three treatment regimens.

To determine response and PFS of patients initially on the bendamustine in combination with rituximab arm who cross over to ibrutinib.

To determine whether baseline cytogenetic markers, Zap-70 methylation, IgVH mutational status, or select DNA mutations predict outcomes or time to response in these three arms.

To determine whether local FISH results for del(11q22.3) and del(17p13.1) are consistent with central analysis.

To determine whether baseline microRNA and gene expression markers are correlated with clinical outcomes of interest (e.g. progression-free and alive at 2 years versus not), as well as to explore changes in microRNA expression from baseline to post-treatment time points, with a focus on those with persistent lymphocytosis and relapse.

To determine whether eradication of MRD predicts longer duration of response with standard therapy and ibrutinib-based regimens.

To describe the baseline functional status, comorbid medical conditions, and number of medications of older CLL patients who meet criteria for therapy.

To determine how functional status changes with therapy using baseline to 3-month evaluation and end-of-study/2-year evaluation; to determine whether this change is different among the treatment groups.

To determine whether geriatric assessment variables known to be associated with chemotherapy toxicity in other disease groups can also predict therapy-associated toxicity in the CLL population.

To assess whether the FCGR3A polymorphism (rs396991) is correlated with depth of response (MRD status) to ibrutinib plus rituximab after six cycles, with secondary endpoints CR rate, rapidity of response, and progression-free survival (PFS).

To assess whether C1QA polymorphism (rs172378) is correlated with MRD status, CR rate, rapidity of response, and PFS.

Patient Population

Patients must be diagnosed with CLL in accordance with IWCLL 2008 criteria as defined in the protocol. Patients must have intermediate or high-risk Rai

stage CLL. Patients must not have any history of Richter's transformation or prolymphocytic leukemia.

Patients must not have had prior therapy for CLL (except palliative steroids or treatment of autoimmune complications of CLL with rituximab or steroids). Treatment with rituximab and/or high dose corticosteroids for autoimmune complications of CLL must be completed at least four weeks prior to enrollment. Palliative steroids must be at a dose not higher than 20 mg/day of prednisone or equivalent corticosteroid at the time of registration. Patients must not be receiving active systemic anticoagulation with heparin or warfarin. Patients must be off warfarin therapy for at least 30 days prior to enrollment. Patients must not have had major surgery within ten days or minor surgery within seven days of enrollment.

Patients must be at least 65 years of age and have ECOG performance status of 0-2. Patients with active hepatitis B are not eligible. Patients with a positive hepatitis B core antibody but with negative hepatitis B DNA may participate, but must have hepatitis serologies and hepatitis B DNA monitored periodically. Patients must not have uncontrolled active systemic infection requiring intravenous antibiotics. Patients must have adequate hematologic, renal, cardiac and hepatic function. Patients with known HIV are eligible if their CD4 count is ≥ 350 cells/mm³ and if they are not taking prohibited CYP-interacting medications. Patients must not have a known allergy to mannitol or prior significant hypersensitivity to rituximab.

Stratification/Descriptive Factors

Patients are stratified by (1) Rai stage: intermediate vs high; (2) presence or absence of del(11q22.3) or del(17p13.1) on FISH; and (3) methylation of CpG 3 on Zap-70: $< 20\%$ vs $\geq 20\%$. In the event that a sample does not yield a Zap-70 methylation status, data will be input based on IgVH mutation status: > 20 if IgVH mutated or < 20 for unmutated.

Accrual Goals

A total of 498 evaluable patients will be accrued to this study. The study will conduct three interim analyses taking place after approximately 33%, 50% and 75% of events have occurred.

Summary Statement

For the current status of this study, please refer to the Leukemia chapter.

B55 Phase III SWOG Supported CTSU Study

Coordinating Group: NRG

A Randomised, Double-Blind, Parallel Group, Placebo-Controlled Multi-Centre Phase III Study to Assess the Efficacy and Safety of Olaparib Versus Placebo as Adjuvant Treatment in Patients with Germline *BRCA1/2* Mutations and High Risk HER2 Negative Primary Breast Cancer Who Have Completed Definitive Local Treatment and Neoadjuvant or Adjuvant Chemotherapy

Participants:
NRG, CTSU

Date Activated:
07/03/2014

Study Chairs:
C Geyer (NRG), P Sharma (SWOG)

SCHEMA

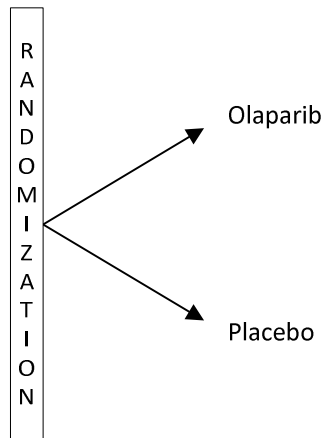

Objectives

The primary objective is to assess the effect of adjuvant treatment with olaparib on Invasive Disease Free Survival (IDFS).

To assess the safety and tolerability of adjuvant treatment with olaparib.

To assess the effect of adjuvant treatment with olaparib on overall survival (OS).

To assess the effect of adjuvant treatment with olaparib on Distant Disease Free Survival (DDFS).

To assess the effect of adjuvant treatment with olaparib on the incidence of new primary contralateral breast cancers (invasive and non-invasive), new primary ovarian cancer, new primary fallopian tube cancer and new primary peritoneal cancer.

To assess the effect of olaparib on patient reported outcomes using the FACIT-Fatigue and EORTC QLQ-C30 QOL questionnaires.

To assess the efficacy of olaparib in patients identified as having a deleterious or suspected deleterious variant in either of the **BRCA** genes using variants identified with current and future **BRCA** mutation assays (gene sequencing and large rearrangement analysis).

To determine the exposure to olaparib (in plasma) in patients receiving olaparib as adjuvant therapy.

Patient Population

Patients must have histologically confirmed non-metastatic primary invasive adenocarcinoma of the breast that is high risk as described in the protocol, with documented mutation in **BRCA1** or **BRCA2** that is predicted to be deleterious or suspected deleterious.

Patients must have completed adequate breast and axilla surgery with clear margins as defined in the protocol. Patients must have completed at least six cycles of neoadjuvant or adjuvant chemotherapy containing anthracyclines, taxanes, or the combination of both. Prior platinum as potentially curative treatment for prior cancer (e.g. ovarian) or as adjuvant or neoadjuvant treatment for breast cancer is allowed. Patients must not have received systemic chemotherapy within three weeks prior to start of study treatment, adjuvant radiotherapy within two weeks prior to start of study treatment, exposure to an investigational product within 30 days or five half lives (whichever is longer) prior to randomization, or any previous treatment with a PARP inhibitor.

Patients must be at least 18 years of age and have ECOG performance status 0-1 and adequate hematologic, hepatic, cardiac, and renal function. Female patients must be postmenopausal or evidence of non-childbearing status as defined in the protocol. Patients must not have known active Hepatitis B or C, HIV, previous allogeneic bone marrow transplant, or whole blood transfusions in the 120 days prior to study entry which may interfere with **gBRCA** testing. FFPE tumor sample from the primary tumor is required unless waived by Study Team if tumor is not available.

Stratification/Descriptive Factors

Patients will be stratified at randomization by the following baseline factors: (1) hormone receptor status: ER/PgR positive/HER2 negative vs TNBC; (2) prior therapy: neoadjuvant vs adjuvant; and (3) prior platinum therapy for current breast cancer: yes vs no.

Accrual Goals

Approximately 1,500 patients will be randomized into the study. An interim analysis will be performed when 165 IDFS events have been observed from the first 750 patients recruited, estimated to be approximately 4.5 years after the first patient is randomized.

Summary Statement

For the current status of this study, please refer to the Breast chapter.

C30610 Phase III SWOG Supported CTSU Study

Coordinating Group: Alliance

Phase III Comparison of Thoracic Radiotherapy Regimens in Patients with Limited Small Cell Lung Cancer Also Receiving Cisplatin or Carboplatin and Etoposide

Participants:
Alliance, CTSU

Date Activated:
03/15/2008

Study Chairs:
J Bogart (Alliance), L Gaspar (SWOG)

SCHEMA

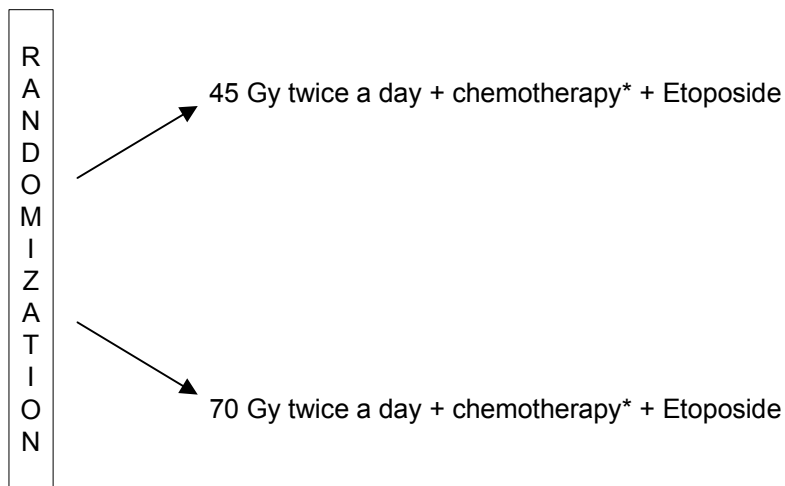

* Investigator could choose either cisplatin chemotherapy or carboplatin chemotherapy

Objectives

To determine whether administering high dose thoracic radiotherapy, 70 Gy or 61.2 Gy, will improve median and two-year survival compared with 45 Gy in patients with limited stage small cell lung cancer.

To compare treatment related toxic effects of thoracic radiotherapy regimens in patients with limited stage small cell lung cancer.

To compare response rates, failure-free survival, and toxicity between these thoracic radiotherapy regimens.

To compare rates of local relapse, distant metastases, and brain metastases.

To compare patients' quality of life between these treatment regimens in terms of their physical symptoms, physical functioning, and psychological state.

To describe the patterns of use of thoracic intensity modulated radiation therapy (IMRT) in patients with limited stage small cell lung cancer.

To examine blood-based biomarkers of response and resistance to cisplatin and etoposide.

Patient Population

Patients must have histologically or cytologically documented limited stage small cell lung cancer. Patients must not have had prior radiotherapy or chemotherapy (except one and only one cycle of carboplatin or cisplatin and etoposide) for limited stage small cell lung cancer. Patients with complete surgical resection of disease are not eligible.

Patients must have adequate hematologic, hepatic, and renal function with an ECOG performance status of 0-2. Patients must be offered participation in the substudies for correlative science (C150712) and quality of life (C7072).

Stratification/Descriptive Factors

Treatment randomization will be stratified by the following factors: (1) gender: male vs female; (2)

weight loss during the six months prior to study entry: $\leq 5\%$ vs $> 5\%$; (3) performance status: 0 vs 1 vs 2; (4) radiotherapy technique: IMRT vs 3D; (5) radiation start time (choose one): at first cycle of protocol chemotherapy, after one cycle of prior non-protocol chemotherapy vs at first cycle of protocol chemotherapy, without prior non-protocol chemotherapy vs at second cycle of protocol chemotherapy, without prior non-protocol chemotherapy; (6) chemotherapy backbone: carboplatin vs. cisplatin.

Accrual Goals

The implementation of the study will be divided into two stages (see protocol for details) and will enroll 729 patients.

Summary Statement

For the current status of this study, please refer to the Lung chapter.

C51101 Phase II SWOG Supported CTSU Study

Coordinating Group: Alliance

A Randomized Phase II Trial of Myeloablative versus Non-myeloablative Consolidation Chemotherapy for Newly Diagnosed Primary CNS-B-cell Lymphoma

Participants:
Alliance, CTSU

Date Activated:
07/01/2012

Study Chairs:
T Batchelor (Alliance), N Mohile (SWOG)

SCHEMA

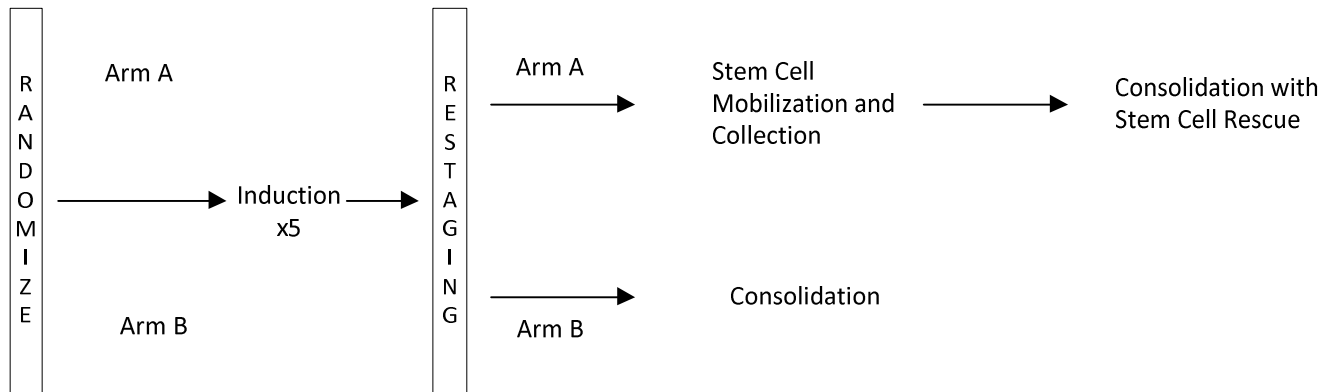

Objectives

To compare the two-year progression-free survival (PFS) of patients treated with the myeloablative consolidation treatment strategy of HDT/ASCT versus those treated with non-myeloablative consolidation chemotherapy with cytarabine and etoposide.

To compare the two-year event-free survival (EFS) and the overall survival (OS) of patients treated with consolidation HDT/ASCT versus those treated with consolidation chemotherapy consisting of etoposide and cytarabine.

To assess the toxicities associated with consolidation HDT/ASCT versus consolidation consisting of etoposide and cytarabine.

To determine diffusion MRI metrics (ADC_{mini} , $ADC_{25\%}$, and ADC_{mean}) prior to induction chemotherapy, after one full induction chemotherapy cycle, and at the end of induction chemotherapy as a predictor of response and outcome.

To determine brain FDG-PET metrics (tumor SUV and tumor versus background SUV) prior to induction chemotherapy, after one full induction chemotherapy cycle, and at the end of induction chemotherapy as a predictor of response and outcome.

To determine whether low baseline ADC measurements are associated with shorter PFS and OS.

To determine whether reduction in tumor SUV by > 25% on brain FDGPET/CT after one cycle of induction therapy is associated with improved PFS and OS.

To determine which IHC-based biomarkers are predictive of an adverse prognosis.

To determine which IHC-based biomarkers are predictive of a favorable prognosis for BCL6 (B-cell CLL/lymphoma 6), and STAT 6 (signal transducer and activator of transcription 6, interleukin-4 induced).

To analyze tumor tissue for gene expression profiles, and to correlate these profiles with treatment outcomes.

To determine whether CSF proteome is a predictor of outcomes (prognostic marker) irrespective of treatment arm for IL-10 (interleukin 10) and C3 (complement component 3).

To assess the neurocognitive function of patients treated with consolidation HDT/ASCT versus those treated with consolidation chemotherapy (etoposide and cytarabine) as measured by serial administration of the International PCNSL Collaborative Group (IPCG) neurocognitive battery and evaluate the long-term survivorship differences between the two arms.

To assess the quality of life of patients treated with consolidation HDT/ASCT versus those treated with consolidation etoposide and cytarabine as measured by the EORTC Quality of Life Questionnaire-Core 30/Brain Cancer Module-20 (EORTC-QLQ30/BCM20), and to evaluate the long-term survivorship differences between the two arms.

Patient Population

Patients must have confirmed central nervous system (CNS) diffuse large B-cell lymphoma. Patients must have no evidence or history of non-Hodgkin lymphoma (NHL) outside of CNS. Patients must not have isolated ocular lymphoma .

Patient must not have received any prior chemotherapy or radiation therapy for lymphoma. Patients must have no history of organ transplantation or ongoing immunosuppressant therapy.

Patients must be between 18 to 75 years old and have Karnofsky Performance Scale (KPS) ≥ 30 (≥ 50 for patients ages 60-70). Patients must have adequate cardiac, pulmonary, hematologic, renal, and hepatic function. Patients must have negative HIV serology and negative HCV serology (unless HBsAb positive patients have recently received HBV vaccine, in this case HBcAb should be negative).

Stratification/Descriptive Factors

Patient randomization will be stratified by age and KPS score: age < 51 years vs age ≥ 51 years and KPS ≥ 70 vs age ≥ 51 years and KPS < 70.

Accrual Goals

A total of 160 patients will be accrued to this study (80 per arm).

Summary Statement

For the current status of this study, please refer to the Lymphoma chapter.

E1411 Phase II SWOG Supported CTSU Study

Coordinating Group: ECOG-ACRIN

Intergroup Randomized Phase II Four Arm Study in Patients with Previously Untreated Mantle Cell Lymphoma of Therapy with: Arm A = Rituximab + Bendamustine Followed by Rituximab Consolidation (RB → R), Arm B = Rituximab + Bendamustine + Bortezomib Followed by Rituximab Consolidation (RBV → R), Arm C = Rituximab + Bendamustine Followed by Lenalidomide + Rituximab Consolidation (RB → LR) or Arm D = Rituximab + Bendamustine + Bortezomib Followed by Lenalidomide + Rituximab Consolidation (RBV → LR)

Participants:
ECOG-ACRIN, CTSU

Date Activated:
06/15/2012

Study Chairs:
M Smith (ECOG-ACRIN), B Till (SWOG)

SCHEMA

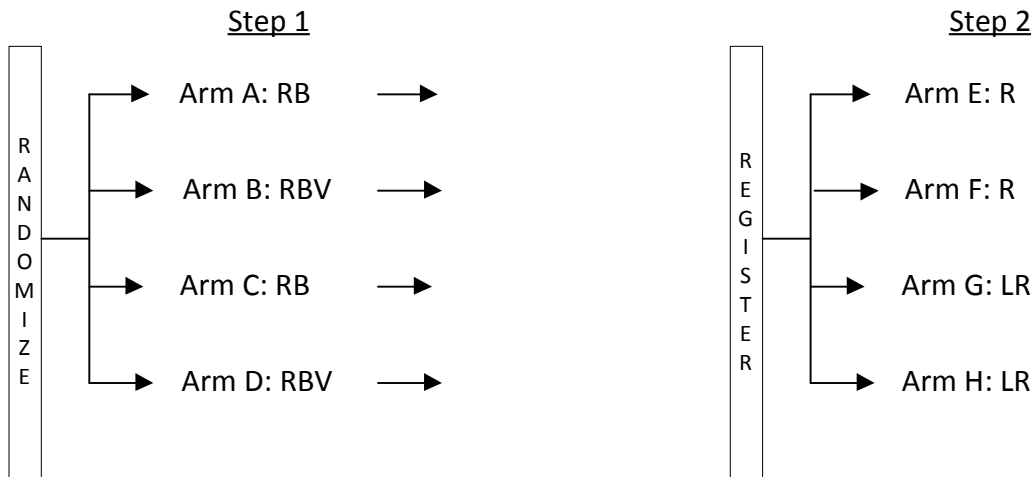

RB: Rituximab + Bendamustine
RBV: Rituximab + Bendamustine + Bortezomib

R: Rituximab
LR: Lenalidomide + Rituximab

Objectives

To determine whether the addition of bortezomib (RBV) to an induction regimen of rituximab

bendamustine (RB) improves progression-free survival (PFS) compared to RB alone in patients with previously untreated mantle cell lymphoma.

To determine whether the addition of lenalidomide to a consolidation regimen of rituximab following an induction regimen of RB or RBV improves PFS compared to consolidation rituximab alone in this patient population.

To determine whether the addition of bortezomib to induction therapy improves the PET-documented complete response rate compared to RB alone.

To determine the objective response rate (ORR) for RB and RBV.

To determine whether the addition of lenalidomide to consolidation therapy improves CR and ORR compared with rituximab alone among patients who do not have PET-documented CR at the end of induction.

To determine overall survival (OS) in the treatment arms.

To determine safety, with attention to the addition of bortezomib in the induction regimen and lenalidomide-rituximab as consolidation therapy.

To determine the extent and severity of neuropathy associated with the addition of bortezomib to induction treatment using patient-reported outcomes data.

To determine the extent of severity of fatigue associated with the addition of lenalidomide to consolidation treatment using patient-reported outcomes data.

To evaluate the effects of the addition of bortezomib and lenalidomide and the effect of bortezomib-related neuropathy on patient-reported health-related quality of life.

To evaluate the response of lymphoma-specific symptoms to treatment.

To describe the trajectory of lymphoma symptoms, neuropathy, fatigue and overall health-related quality of life prior to, during and following treatment among older adults with MCL using longitudinal patient-reported outcomes data.

See protocol for objectives for laboratory correlative studies, imaging correlative studies, and residual disease assessment by molecular and flow cytometric techniques.

Patient Population

Patients must have histologically confirmed untreated mantle cell lymphoma (MCL). Patients must have at least one objective measurable disease parameter. Patients must have no known CNS involvement.

Patients must not have received prior therapy for MCL, except less than two weeks of steroid therapy for symptom control if there is measurable disease outside the radiation portal. Patients may be on chronic steroids for non-malignant disease if on a stable dose equivalent to ≤ 20 mg prednisone per day. Patients must not be participating in any other clinical trial or taking any other experimental medications within 14 days prior to registration.

Patients must have ECOG performance status 0-2 and adequate cardiac, hematologic, renal, and hepatic function. Patients must not have Grade 2 or greater peripheral neuropathy. HIV positive patients are not excluded, but may enroll with restrictions. Patients must have no hypersensitivity to bortezomib, boron or mannitol. Patients must agree that if randomized to Arms C or D, and proceed onto Arms G and H, they must register into the mandatory RevAssist program. Patients must have no medical contra-indications to DVT prophylaxis.

Stratification/Descriptive Factors

Patient randomization will be stratified according to the following factors: (1) mantle cell lymphoma IPI (MIPI) risk status: low risk vs intermediate risk vs high risk; and (2) age: < 60 vs ≥ 60 .

Accrual Goals

A total of 372 patients will be accrued to this study.

Summary Statement

For the current status of this study, please refer to the Lymphoma chapter.

E1912 Phase III SWOG Supported CTSU Study

Coordinating Group: ECOG-ACRIN

A Randomized Phase III Study of Ibrutinib (PCI-32765)-based Therapy vs Standard Fludarabine, Cyclophosphamide, and Rituximab (FCR) Chemoimmunotherapy in Untreated Younger Patients with Chronic Lymphocytic Leukemia (CLL)

Participants:
ECOG-ACRIN, CTSU

Date Activated:
02/07/2014

Study Chairs:
T Shanafelt (ECOG-ACRIN), S O'Brien (SWOG)

Date Closed:
06/09/2016

SCHEMA

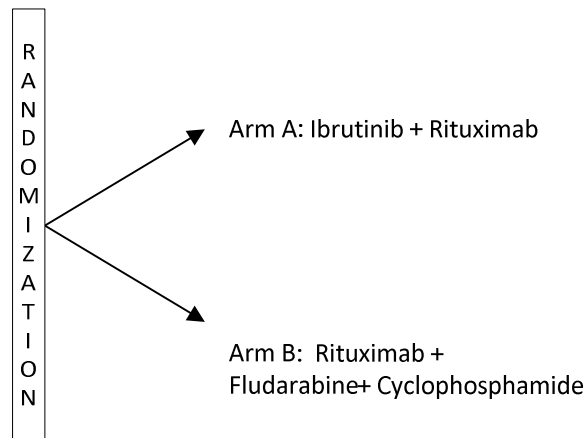

Objectives

The primary objective for the trial is to evaluate the ability of ibrutinib-based induction therapy to prolong progression free survival (PFS) compared to standard FCR chemoimmunotherapy for younger patients with CLL.

To evaluate overall survival (OS) of patients based on treatment arm.

To monitor and assess toxicity of treatment with ibrutinib-based induction relative to standard FCR chemotherapy.

To compare quality of life (QOL) in CLL patients during the first six months of treatment among patients receiving ibrutinib-based induction therapy relative to standard FCR chemoimmunotherapy.

To compare QOL over the long-term in CLL patients receiving continuous therapy using ibrutinib to that of CLL patients who completed FCR therapy.

To determine the effect of pretreatment clinical and biological characteristics on clinical outcomes of the different arms.

To determine if the minimal residual disease (MRD) status as assessed by flow cytometry at different time points during and after treatment is an effective surrogate marker for prolonged PFS and overall survival.

To compare the genetic abnormalities and dynamics of intra-clonal architecture of CLL patients before and after treatment with CIT and non-CIT approaches and explore relationships with treatment resistance.

To explore the effects of FCR and ibrutinib-based therapy on T-cell immune function.

To conduct confirmatory validation genotyping of single nucleotide polymorphisms (SNPs) associated with the efficacy and toxicity of fludarabine-based therapy as in a prior ECOG GWAS analysis in the E2997 trial.

To evaluate the ability of a prognostic model that incorporates clinical and biologic characters to predict a response to therapy and clinical outcome (PFS, OS).

To evaluate signaling networks downstream of the B-cell receptor in patients receiving ibrutinib-based therapy.

To collect relapse samples to study mechanisms of resistance to both FCR and ibrutinib-based therapy.

Patient Population

Patients must have a diagnosis of CLL according to the NCI/IWCLL criteria or SLL according to the WHO criteria. Patients must meet at least one of the indications for treatment of CLL or small lymphocytic leukemia (SLL) listed in the protocol. Patients must not have deletion of 17p13 on cytogenetic analysis by FISH.

Patients must not have had prior chemotherapy or monoclonal anti-body therapy for treatment of CLL or SLL. Patients must not have had previous use of corticosteroids for autoimmune complications that have developed since the initial diagnosis of CLL. Patients must not have had major surgery within 28 days of first dose of study drug or minor surgery

within three days of first dose of study drug. Patients must not have had radiation therapy within four weeks prior to registration. Patients must not have received warfarin or another vitamin K antagonist in the preceding 30 days.

Patients must be between 18 and 70 years of age, life expectancy of at least 12 months, and have an ECOG performance status of 0-2. Patients must have adequate renal, hepatic and cardiac function. Patients must not have active hemolytic anemia requiring immunosuppressive therapy or other pharmacologic treatment. Patients with HIV infection may be eligible provided they meet the criteria listed in the protocol. Patients must not have uncontrolled infection or infection with known chronic, active hepatitis C, or positive serology for hepatitis B. Patients must not have had a cerebral vascular accident or intracranial bleed within the last six months. Patients must not have any known bleeding disorders or any of the gastrointestinal disorders listed in the protocol. Patients must not be vaccinated with live, attenuated vaccines within 4 weeks of first dose of study drug.

Stratification/Descriptive Factors

At randomization, patients will be stratified as follows: (1) age at registration: < 60 years vs \geq 60 years; (2) ECOG performance status: 0 or 1 vs 2; (3) disease stage: 3 or 4 vs 1 or 2; (4) baseline cytogenetic abnormalities on FISH: deletion 11q22.3(ATM) vs other.

Accrual Goals

The accrual goal of this study is 519 patients: 346 in arm A (Ibrutinib) and 173 patients in arm B (FCR). The first interim analysis will be performed when follow-up is available through the later of five years after the start of accrual or two years after accrual is completed. If this study is not at full information at this time, then interim analyses will be performed annually until full information is reached.

Summary Statement

For the current status of this study, please refer to the Leukemia chapter.

E1A11 Phase III SWOG Supported CTSU Study

Coordinating Group: ECOG-ACRIN

Randomized Phase III Trial of Bortezomib, LENalidomide and Dexamethasone (VRd) Versus Carfilzomib, Lenalidomide and Dexamethasone (CRd) Followed by Limited or Indefinite DURATION Lenalidomide MaintenANCE in Patients with Newly Diagnosed Symptomatic Multiple Myeloma (ENDURANCE)

Participants:
ECOG-ACRIN, CTSU

Date Activated:
11/22/2013

Study Chairs:
S Kumar (ECOG-ACRIN), A Cohen, J Zonder (SWOG)

SCHEMA

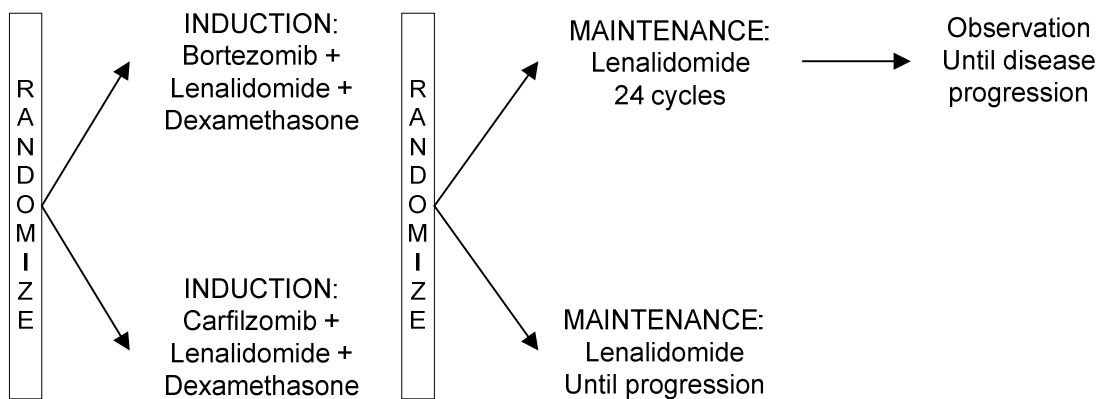

Objectives

To compare overall survival with the two different lenalidomide maintenance strategies

To compare the progression-free survival and safety of each lenalidomide maintenance approach

To compare the progression-free survival between induction treatments

To compare rates of response, duration of response, time to progression, overall survival, and safety of the induction therapies

Patient Population

Patients must have been diagnosed with symptomatic standard-risk multiple myeloma within the last 90 days and have measurable or evaluable disease.

Patients must not have received lenalidomide, bortezomib, or carfilzomib for the treatment of symptomatic myeloma.

Patients must be at least 18 years of age with an ECOG performance status of 0-2, although 3 is allowed if it is secondary to pain. Patients must have adequate hepatic, renal and hematologic function. Prior malignancies are allowed if treated with

curative intent that does not require active therapy. Glucocorticoid use is restricted following registration. Patients must use effective contraception.

Stratification/Descriptive Factors

At registration to induction therapy, patient randomization will be stratified by intent to stem cell transplant at progression: yes vs no. At registration to maintenance therapy, patient randomization will be stratified by induction treatment: Arm A vs Arm B.

Accrual Goals

Seven hundred fifty-six patients will be accrued to this study.

Summary Statement

For the current status of this study, please refer to the Myeloma chapter.

E1Z11 Cohort SWOG Supported CTSU Study

Coordinating Group: ECOG-ACRIN

A Cohort Study to Evaluate Genetic Predictors of Aromatase Inhibitor Musculoskeletal Symptoms (AIMSS)

Participants:

ECOG-ACRIN, CTSU

Date Activated:

05/31/2013

Study Chairs:

V Stearns (ECOG-ACRIN), N Henry (SWOG)

Objectives

To validate previously identified associations between 10 specific single nucleotide polymorphisms (SNPs) and discontinuation of treatment with aromatase inhibitors (AIs) due to the development of musculoskeletal symptoms (MSS) among women with breast cancer.

To determine whether other SNPs in CYP, UGT, Vitamin D, serotonin and other receptors are associated with discontinuation of treatment due to the development of severe AIMSS.

To determine whether other SNPs in CYP, UGT, Vitamin D, serotonin and other receptors are associated with the development of other potential complications of AI therapy.

To develop a gene signature that can identify patients at risk for developing severe anastrozole-related AIMSS and other potential complications of AI therapy.

To determine the epidemiology and predictors of severe AIMSS and of AI discontinuation.

To describe patient reported outcomes for minority patients with breast cancer treated with AIs.

To assess the utility of the PROMIS system to collect patient reported outcomes in a cooperative group study, and validate the PROMIS Physical Function 20a form in patients with AIMSS.

To develop a model that incorporates patient ratings of treatment burden, fear of recurrence and adherence behaviors to describe patient decisions to continue or discontinue anastrozole.

To collect serum samples for future testing for biomarkers of AIMSS.

Patient Population

Patients must be female and post-menopausal as defined in the protocol, with estrogen and/or progesterone receptor positive histologically confirmed Stage I-III adenocarcinoma of the breast. Patients must not have prior history of ovarian, endometrial, or fallopian tube carcinoma, and/or primary peritoneal carcinomatosis.

Patients must have completed planned local therapy (i.e., definitive surgery and radiation therapy) and adjuvant chemotherapy for breast cancer, with plans to treat with anastrozole for at least 12 months. Concomitant treatment with ongoing trastuzumab (Herceptin®) or other targeted/biologic agents is allowed. Concomitant treatment with any other type of chemotherapy or hormonal therapy is not allowed. Patients must not have received prior AI therapy with exemestane, letrozole, or anastrozole as preoperative/adjuvant therapy or for prevention of breast cancer. Prior tamoxifen is allowed.

Patients must have adequate hepatic, hematologic and renal functioning to be able to be administered anastrozole at the discretion of the treating physician. Patients must have worst pain rated as no worse than 3 out of 10 on the following question (i.e., a pain

score of 0, 1, 2, or 3): "In the past week, how much pain have you had on a scale of 0 to 10, where 0 equals no pain and 10 means the worst pain you can imagine." NOTE: This question regarding patient's pain should be completed within one week prior to registration. This pain item may be completed orally prior to consent up to seven days prior to registration. Patients must not be currently taking (or have taken in the past six months) medication for active, chronic conditions, including rheumatoid arthritis, carpal tunnel syndrome, tenosynovitis, systemic lupus erythematosus, gout, fibromyalgia, or severe osteoarthritis involving the hands, wrists, hips, knees, feet or ankles. This includes analgesic medications or medications being taken with the purpose of treating pain or that may have an effect on pain (e.g. anti-depressants for help with pain or neuropathy, corticosteroid shots for arthritis). Patients taking daily

low dose aspirin are allowed to participate in this trial.

Patients must be at least 18 years old, have an ECOG performance status of 0-2, and must not have a prior history of deep vein thrombosis (DVT) or pulmonary embolism in the past five years.

Accrual Goals

The accrual goal is 1000 patients, including 200 Asian and 200 African American.

Summary Statement

For the current status of this study, please refer to the Breast chapter.

E2810 Phase III SWOG Supported CTSU Study

Coordinating Group: ECOG-ACRIN

Randomized, Double-Blind Phase III Study of Pazopanib vs. Placebo in Patients with Metastatic Renal Cell Carcinoma Who Have No Evidence of Disease Following Metastatectomy

Participants:
ECOG-ACRIN, CTSU

Date Activated:
04/17/2012

Study Chairs:
L Appleman (ECOG-ACRIN), S Pal (SWOG)

SCHEMA

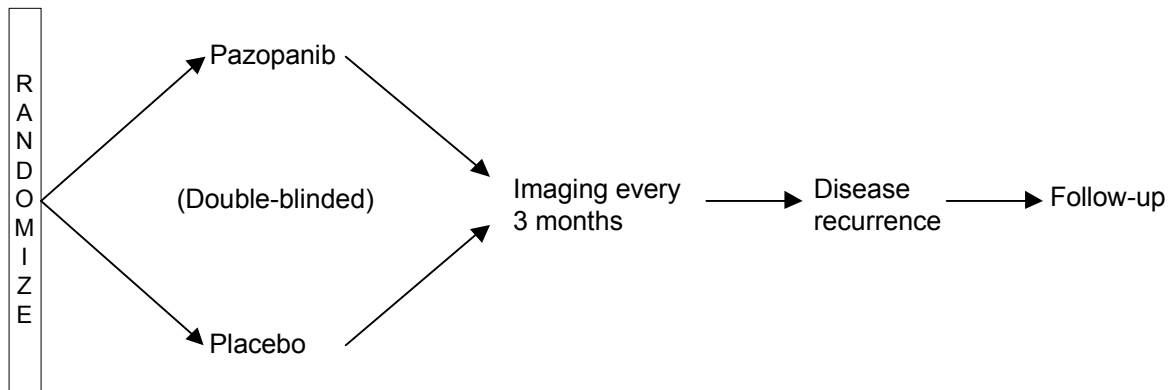

Objectives

To evaluate disease-free survival of patient with renal cell carcinoma (RCC) treated with pazopanib as compared to placebo.

To describe the overall survival of patients with advanced RCC randomly assigned to receive placebo or pazopanib for one year following metastatectomy to NED.

To describe treatment- and (at recurrence) disease-related adverse events in the two treatment arms.

To analyze quality-adjusted time without symptoms of disease or treatment (Q-TWiST) for subjects in the two treatment arms.

To characterize changes in patient-reported fatigue and (at recurrence) kidney cancer-related symptoms during and following treatment with pazopanib compared to placebo.

To explore the association between plasma trough levels of pazopanib and disease-free and overall survival.

To prospectively bank preserved tissue from primary tumors and associated metastatic sites in patients with RCC.

Patient Population

Patients must have pathologically confirmed renal cell carcinoma with a clear cell component. Pure papillary and chromophobe histologies are excluded.

Patients must have undergone nephrectomy or partial nephrectomy to remove primary renal cell carcinoma. Patients must have undergone surgical resection to remove one or more sites of metastatic disease, with successful removal of all known sites two to twelve weeks prior to randomization. Eligible patients must have no evidence of disease on post-operative imaging. Patients must not have received any prior or concurrent systemic therapy for RCC; prior adjuvant placebo administration is permitted. Patients cannot be taking strong CYP3A4 inhibitors. Patients must not be taking drugs known to prolong the QTc interval; such drugs should be discontinued at least one week prior to randomization.

Patients must have ECOG performance status of 0 or 1 and adequate hematologic, renal, hepatic, and cardiac function. Patients must have no uncontrolled intercurrent illness. Patients must have no history of abdominal fistula, gastrointestinal perforation, or intra-abdominal abscess, myocardial infarction, cerebrovascular accident (CVA), hospital admission

for unstable angina, cardiac angioplasty, or stenting, venous thrombosis, or hemoptysis in excess of 2.5 mL.

Stratification/Descriptive Factors

Patient randomization will be stratified according to the following factors: (1) disease-free interval: ≤ 1 year vs > 1 year; and (2) number of sites of metastatic disease resected at metastatectomy: 1 vs >1 .

Accrual Goals

The accrual goal for this study is 128 patients (64 per arm). Interim analyses will be performed after 31% information is attained and then every six months until full information.

Summary Statement

For the current status of this study, please refer to the Genitourinary chapter.

E2906 Phase III SWOG Supported CTSU Study

Coordinating Group: ECOG-ACRIN

Phase III Randomized Trial of Clofarabine as Induction and Post-Remission Therapy vs. Standard Daunorubicin & Cytarabine Induction and Intermediate Dose Cytarabine Post-Remission Therapy, Followed by Decitabine Maintenance vs. Observation in Newly-Diagnosed Acute Myeloid Leukemia in Older Adults (Age \geq 60 Years)

Participants:
ECOG-ACRIN, CTSU

Date Activated:
02/24/2011

Study Chairs:
J Foran (ECOG-ACRIN), J Godwin (SWOG)

Date Closed*:
02/23/2015

* Temporary closure

SCHEMA

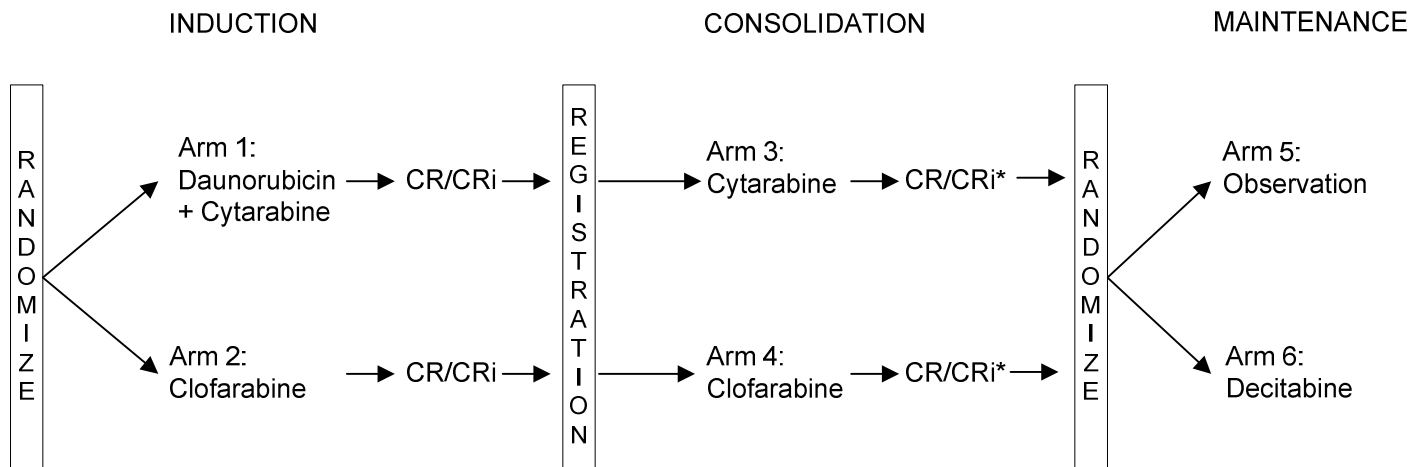

*Note: Patients with an HLA matched donor who achieve CR/CRi or morphologic leukemia-free state will proceed to allogeneic Hematopoietic Stem Cell Transplantation after consolidation.

Objectives

To evaluate the effect of clofarabine induction and consolidation therapy on overall survival in comparison with standard therapy (daunorubicin +

cytarabine) in newly-diagnosed AML patients age 60 years and older.

To evaluate complete remission (CR) rates, duration of remission, and toxicity/treatment-related mortality of clofarabine in comparison with standard therapy

(daunorubicin + cytarabine) in newly-diagnosed AML patients age 60 years and older.

To evaluate the feasibility of consolidation with reduced-intensity conditioning and allogeneic hematopoietic stem cell transplantation from HLA-identical donors in patients who achieve a response to induction therapy, including the incidence of successful engraftment, acute and chronic graft-versus-host disease, transplant-related mortality, and its impact on overall survival in comparison to patients receiving chemotherapy.

To evaluate the duration of remission and disease-free survival of patients in complete remission following completion of consolidation therapy who are subsequently randomized to receive scheduled low-dose decitabine maintenance in comparison with observation.

To perform expression and methylation profiling on all patients receiving decitabine and to correlate their integrated epigenetic signatures with response to decitabine.

To examine the epigenetic profiles of remission marrow in patients randomized to observation vs. decitabine to determine whether epigenetic signature of apparently morphologically normal bone marrow is predictive of relapse or response to decitabine maintenance.

To explore the possible association of response to clofarabine with ABC-transporter P-glycoprotein (Pgp).

To assess the intensity of expression of CXCR4 on diagnostic leukemia cells and to correlate this parameter with other established prognostic factors.

To assess the entire spectrum of somatic mutations and affected pathways at diagnosis of AML and elucidate the association between gene mutation and outcome.

To examine the impact of smoking, obesity, regular acetaminophen use, regular aspirin use, benzene exposure, living in a rural/farm environment and some other underlying exposures and lifestyle factors associated with AML development on OS.

To investigate potential correlative results between array CGH findings and acute myeloid leukemia patient characteristics.

To compare health-related QOL (physical, functional, leukemia-specific well-being) and fatigue in elderly AML patients receiving standard induction therapy with those receiving clofarabine.

To measure the change in health-related QOL that occurs over time (within treatment groups).

To comprehensively assess patient function at the time of study enrollment.

To determine if components of a comprehensive geriatric assessment of QOL scales predict ability to complete AML treatment.

To describe the impact of transplant on QOL in AML patients above age 60.

Patient Population

Patients must have newly-diagnosed AML according to WHO classification and be considered candidates for intensive chemotherapy based upon examination of peripheral blood, bone marrow aspirate specimens, or touch preparations of the bone marrow biopsy. Patients must not have blastic transformation of chronic myelogenous leukemia. Patients with secondary AML are eligible. Patients with documented CNS involvement are not eligible.

Patients must not have received prior chemotherapy for AML with the exception of hydroxurea for increased blast count or leukapheresis for leukocytosis. Patients who have received a limited and short-term exposure of ATRA (all trans retinoic acid) while AML-M3 (Acute Promyelocytic Leukemia) was being ruled out, and which has been discontinued, will be eligible. Patients with confirmed APL will be excluded. Patients who have received previous treatment for antecedent hematologic disorder (AHD) with 5-azacitidine, decitabine, or low dose cytarabine are not eligible.

Patients must have an ECOG performance status 0-3 and reached their 60th birthday. Patients must have adequate cardiac, hepatic, and renal function. Patients must not have a concurrent active malignancy for which they are receiving treatment (other than MDS). Patients with known HIV infection or any active, uncontrolled infection are not eligible.

Stratification/Descriptive Factors

At initial randomization patients will be stratified by (1) age: 60-69 vs ≥ 70 years; (2) therapy-related

AML: yes vs no; and (3) presence of AHD at the time of diagnosis of AML: yes vs no.

For the randomization to maintenance, treatment randomization will be stratified by (1) age: 60-69 vs ≥ 70 years; (2) cytogenetics: unfavorable vs other; and (3) induction treatment: arm 1 vs arm 2.

Accrual Goals

The accrual goal for this study is 747 patients. Up to

nine interim analyses will be performed beginning when approximately 25% of planned full information has occurred. Interim analyses will include both futility and efficacy analyses.

Summary Statement

For the current status of this study, please refer to the Leukemia chapter.

E3A06 Phase III SWOG Supported CTSU Study

Coordinating Group: ECOG-ACRIN

Randomized Phase III Trial of Lenalidomide versus Observation Alone in Patients with Asymptomatic Smoldering Multiple Myeloma

Participants:
ECOG-ACRIN, CTSU

Date Activated:
02/01/2011

Study Chairs:
S Lonial (ECOG-ACRIN), M Dhodapkar (SWOG)

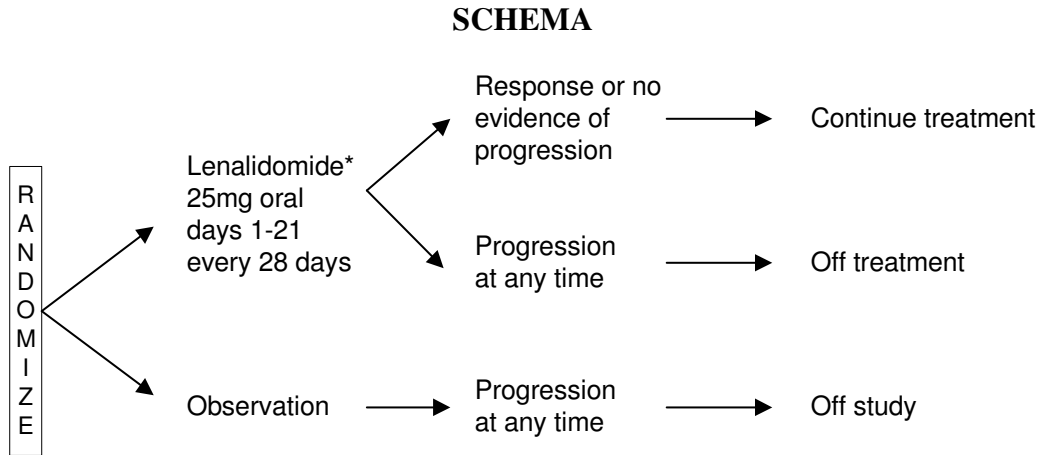

*Mobilize stem cells following 4 cycles of therapy

Objectives

To compare progression free survival where failure is defined as death or the development of symptomatic myeloma indicating treatment between patients receiving lenalidomide versus observation alone in high-risk asymptomatic, smoldering multiple myeloma.

To determine and compare the response rate, time to progression, one-year progression-free survival probability, and overall survival between patients randomized to receive lenalidomide or observation in the setting of asymptomatic myeloma.

To estimate the incidence of adverse events in

patients receiving lenalidomide therapy for early-stage multiple myeloma.

Patient Population

Patients must have previously untreated asymptomatic MM diagnosed within one year prior to registration. Patients with smoldering multiple myeloma (SMM) are eligible. Patients with MGUS are not eligible.

Patients must have received no prior therapy for myeloma or SMM. Prior radiation therapy for the treatment of solitary plasmacytoma is permitted, but more than three months must have elapsed from the last day of radiation.

Patients must be 18 years of age or older. Patients must have an ECOG performance status between 0 and 2 and must not have Grade 2 or higher peripheral neuropathy or active, uncontrolled infection. Patients must not have baseline bone lesions or plasmacytomas.

Accrual Goals

One hundred eighty patients will be randomized with equal allocation to lenalidomide versus observation.

Summary Statement

For the current status of this study, please refer to the Myeloma chapter.

EA6134 Phase III SWOG Supported CTSU Study

Coordinating Group: ECOG-ACRIN

A Randomized Phase III Trial of Dabrafenib plus Trametinib followed by Ipilimumab plus Nivolumab at Progression versus Ipilimumab plus Nivolumab followed by Dabrafenib plus Trametinib at Progression in Patients with Advanced BRAF^{V600} Mutant Melanoma

Participants:
ECOG-ACRIN, CTSU

Date Activated:
07/13/2015

Study Chairs:
M Atkins (ECOG-ACRIN), B Chmielowski (SWOG)

SCHEMA

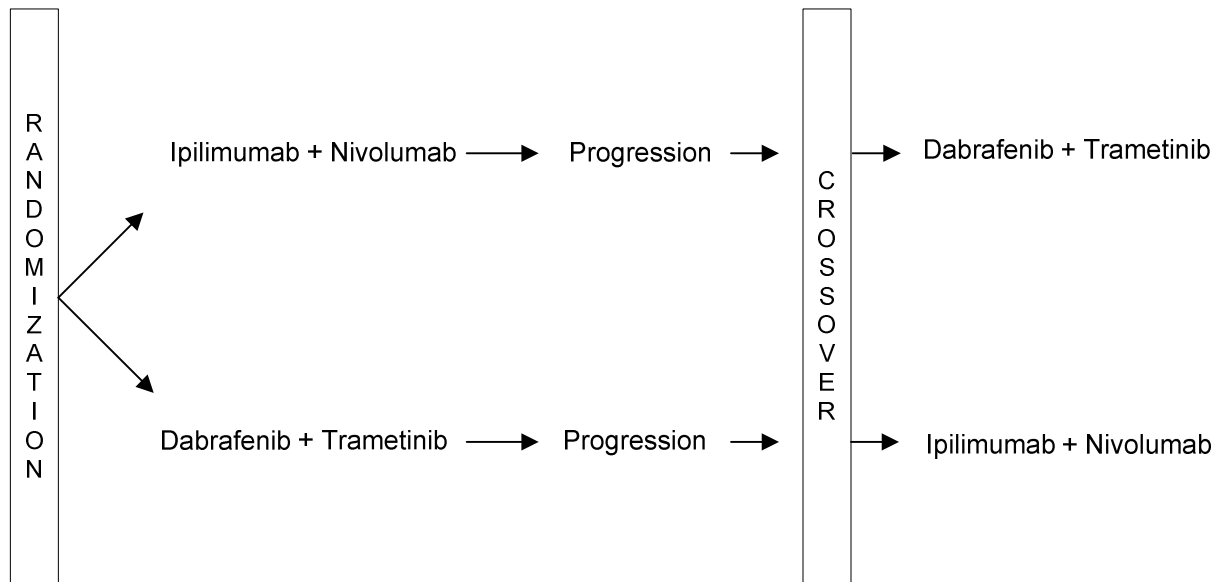

Objectives

To determine whether initial treatment with either combination ipilimumab + nivolumab (with subsequent dabrafenib in combination with trametinib) or dabrafenib in combination with trametinib (with subsequent ipilimumab + nivolumab) significantly improves 2-year overall survival (OS) in patients with unresectable stage III or stage IV BRAF^{V600} mutant melanoma.

To evaluate the impact of initial treatment on overall survival.

To evaluate the anti-tumor activities (RECIST-defined response rate, median PFS) and safety profiles of ipilimumab + nivolumab and dabrafenib + trametinib.

To evaluate the activity (RECIST-defined response rate, median PFS) and safety of dabrafenib + trametinib in patients who have had disease progression on ipilimumab + nivolumab and in comparison to its activity and safety in ipilimumab + nivolumab naïve patients.

To evaluate the activity of ipilimumab + nivolumab (RECIST-defined response rate, median PFS) and safety in patients who have had disease progression on dabrafenib + trametinib and in comparison to its activity and safety in dabrafenib + trametinib naïve patients.

To assess the feasibility of crossover to the alternative treatment strategy, defined as the percentage of patients who are able to crossover from one arm to the other and complete at least an initial course (12 weeks) of treatment after crossover without intervening symptomatic disease progression or treatment limiting toxicity.

Patient Population

Patients must have histological or cytological confirmation of melanoma which is stage IV or unresectable stage III and clearly progressive. Patients must have BRAF^{V600E} or BRAF^{V600K} mutations, identified by an FDA-approved test at a CLIA-certified lab. Patients must have measurable disease as defined by RECIST 1.1. Patients must not have currently active CNS metastases. Patients may have treated brain metastases (with either surgical resection or stereotactic radiosurgery (SRS)) that have been stable on head MRI or contrast CT scan for at least four weeks following treatment and within four weeks prior to randomization, provided they have not have taken any steroids for the purpose of

managing their brain metastases for at least 14 days prior to randomization. Patients with only whole brain irradiation for treatment of CNS metastases are ineligible. Patients with a history of RAS mutation-positive tumors are not eligible. Patients must have aggressive melanoma that results in a serum LDH of more than 10 times the institutional upper limit of normal.

Patients may have had prior systemic therapy in the adjuvant setting; however this adjuvant treatment must not have included a CTLA4 or PD1 pathway blocking antibody or a BRAF/MEK inhibitor. Patients must not have received any prior systemic therapy for stage IV disease. Patients may have received prior radiation therapy or surgery.

Patients must have adequate hematologic, hepatic, and renal function and an ECOG performance status of 0-1. Patients must not have any ongoing or active infections requiring parenteral antibiotics. Patients must not have a history of bleeding diathesis or need for concurrent anticoagulation.

Stratification/Descriptive Factors

Treatment randomization will be stratified by the following: (1) ECOG performance status: 0 vs 1; (2) serum LDH: normal vs elevated (defined as above IULN).

Accrual Goals

Approximately 300 patients will be registered to achieve 270 eligible patients.

Summary Statement

For the current status of this study, please refer to the Melanoma chapter.

N1048 Phase II/III SWOG Supported CTSU Study

Coordinating Group: Alliance

A Phase II/III Trial of Neoadjuvant FOLFOX with Selective Use of Combined Modality Chemoradiation versus Preoperative Combined Modality Chemoradiation for Locally Advanced Rectal Cancer Patients Undergoing Low Anterior Resection with Total Mesorectal Excision

Participants:
Alliance, CTSU

Date Activated:
01/13/2012

Study Chairs:
D Schrag (Alliance), C Eng (SWOG)

SCHEMA

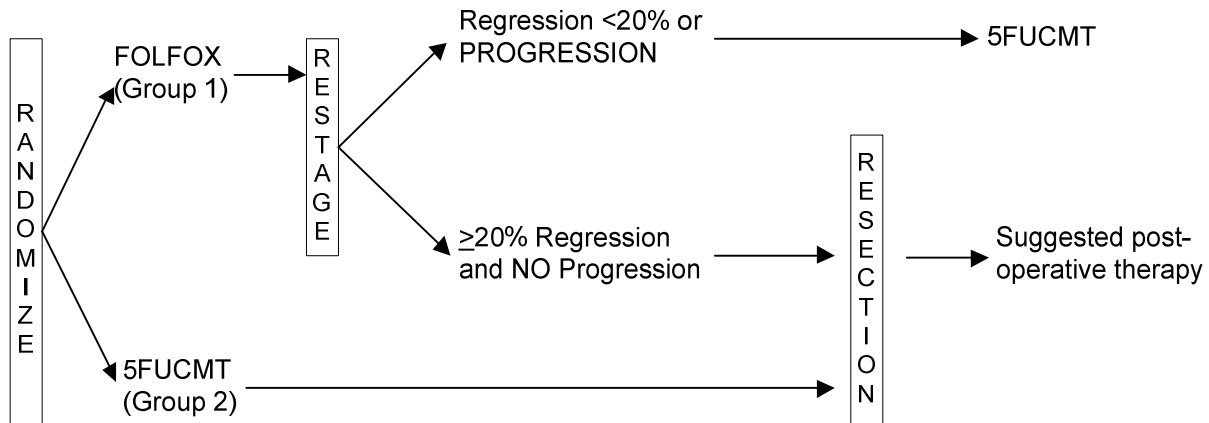

Objectives

Phase II component primary objective:

To assure that neoadjuvant FOLFOX followed by selective use of 5FUCMT group (Group 1) maintains the current high rate of pelvic R0 resection and is consistent with non-inferiority for time to local recurrence (TLR).

Phase III component primary objective:

To compare neoadjuvant FOLFOX followed by selective use of 5FUCMT (Group 1) to standard 5FUCMT (Group 2) with respect to the co-primary

endpoints of the Time to Local Recurrence (TLR) and Disease-free Survival (DFS).

Secondary Objectives:

To determine if the neoadjuvant FOLFOX followed by selective use of 5FUCMT (Group 1) is non-inferior to the standard group 5FUCMT (Group 2) with respect to the proportion of patients who achieve a pathologic complete response (pCR) at the time of surgical resection.

To determine if the neoadjuvant FOLFOX followed by selective use of 5FUCMT (Group 1) is non-

inferior to the standard 5FUCMT (Group 2) with respect to overall survival.

To evaluate and compare the adverse event profile and surgery complications between two groups.

To estimate the proportion of patients in the selective (Group 1) who receive: 1) pre-operative 5FUCMT; 2) post-operative 5FUCMT; 3) either pre- or post-operative 5FUCMT.

Patient Population

Patients must have rectal adenocarcinoma of clinical stage T2N1, T3N0 or T3N1. Patients must have radiologically measurable or clinically evaluable disease with tumor tissue evident between 5 and 12 cm from the anal verge. Tumor must not be adjacent to (within 3 mm of) the mesorectal fascia. Patients must not need abdominoperineal (APR) at baseline.

Patients must not have had chemotherapy within five years prior to registration. Hormonal therapy is allowable if the disease free interval is five years or

longer. Patients must not have had any prior pelvic radiation.

Patients must have an ECOG performance status 0-2 and be at least 18 years of age. Patients must have adequate hematologic, hepatic and renal function.

Stratification/Descriptive Factors

Patients will be stratified by ECOG performance status: 0 or 1 vs 2.

Accrual Goals

There will be total of 500 patients randomized to each group of this study (total of 1060 to get 1000 evaluable patients) if the trial completes the full phase III accrual. The phase II portion is defined as the first 366 randomized patients.

Summary Statement

For the current status of this study, please refer to the Gastrointestinal chapter.

R0848 Phase III SWOG Supported CTSU Study

Coordinating Group: NRG

A Phase III Trial Evaluating Both Erlotinib and Chemoradiation as Adjuvant Treatment for Patients with Resected Head of Pancreas Adenocarcinoma

Participants:
NRG, CTSU

Date Activated:
03/01/2014

Study Chairs:
R Abrams (NRG), P Philip (SWOG)

Statistician:
K Guthrie

SCHEMA

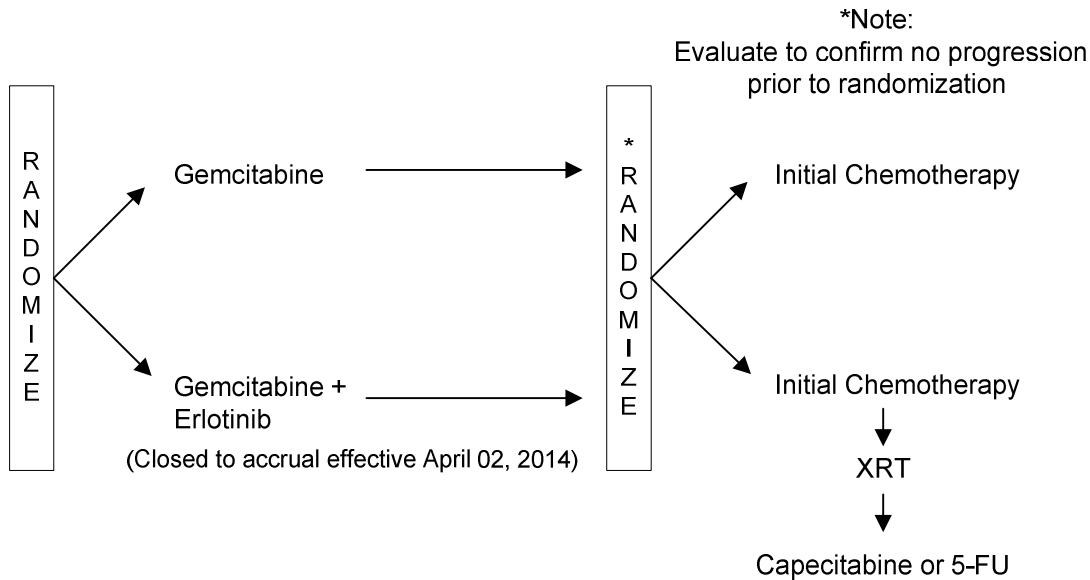

Objectives

To determine whether the addition of erlotinib to gemcitabine adjuvant chemotherapy improves survival as compared to gemcitabine alone following R0 or R1 resection of head of pancreas adenocarcinoma (including adenocarcinoma of the head, neck and uncinate process).

To determine whether the use of concurrent fluoropyrimidine and radiotherapy following adjuvant gemcitabine-based chemotherapy further enhances survival for such patients who are without evidence of progressive disease after five cycles of gemcitabine-based chemotherapy.

To evaluate disease-free survival of adjuvant chemotherapy followed by radiotherapy and concurrent fluoropyrimidine for patients with

resected head of pancreas adenocarcinoma who are disease-free after five cycles of adjuvant chemotherapy.

To evaluate disease-free survival of standard adjuvant gemcitabine chemotherapy with and without erlotinib for patients with resected head of pancreas adenocarcinoma.

To evaluate the disease-free and overall survival of standard adjuvant treatment with and without erlotinib for patients with resected head of pancreas adenocarcinoma by wild-type and mutant KRAS status.

To evaluate adverse events with and without erlotinib for patients with resected head of pancreas adenocarcinoma.

To evaluate adverse events of adjuvant chemotherapy with or without radiation therapy and concurrent fluoropyrimidine for patients with resected head of pancreas adenocarcinoma who are disease-free after adjuvant chemotherapy.

To evaluate preoperative cross-sectional imaging of the primary head of pancreas adenocarcinoma in order to determine the frequency with which objective criteria of resectability are present.

To determine if patients reporting low baseline fatigue, as measured by the FACIT-Fatigue, predicts survival and to explore correlations between baseline fatigue, as measured by PROMIS, and survival.

Patient Population

Patients must have histologic proof of primary head of pancreas invasive adenocarcinoma managed with a potentially curative resection. Patients with invasive adenocarcinoma that also contains a component of intraductal papillary mucinous neoplasm (IPMN) are eligible. Patients must have pathologic stage T1-3,

N0-1 and M0 according to the 6th edition AJCC staging system. Patients with non-adenocarcinomas, adenosquamous carcinomas, islet cell tumors, cystadenomas, cystadenocarcinomas, carcinoid tumors, duodenal carcinomas, distal bile duct or ampullary carcinomas are not eligible.

Patients must have had removal of all gross tumor involving a classic pancreaticoduodenectomy, or a pylorus preserving pancreaticoduodenectomy. This surgery must have occurred within 21 and 56 days of registration. Patients managed with a total pancreatectomy, distal pancreatectomy, or central pancreatectomy are not eligible. Prior chemotherapy for pancreas cancer is not allowed. Patients with prior radiotherapy to the region of the study cancer that would result in overlap of radiation therapy fields are not eligible.

Patients must have adequate hematologic, hepatic and renal function and be at least 18 years of age. Patients must have a Zubrod performance status of 0 or 1. Patients with active HIV infection are eligible if their CD4 count is 499/mm³ or greater and their viral load is 50 copies/ml or less (use of HAART is allowed).

Stratification/Descriptive Factors

At initial randomization patients will be stratified by (1) nodal status: involved vs uninvolved; (2) CA 19-9 results: 90 or less vs > 90-180; and (3) surgical margins: positive vs negative.

Accrual Goals

This study will accrue 950 patients to reach the 640 patients required to be randomized to answer the radiation therapy question. Three interim analyses will be performed.

Summary Statement

For the current status of this study, please refer to the Gastrointestinal chapter.

R1112 Phase III SWOG Supported CTSU Study

Coordinating Group: NRG

Randomized Phase III Study of Sorafenib Versus Stereotactic Body Radiation Therapy Followed by Sorafenib in Hepatocellular Carcinoma

Participants:
NRG, CTSU

Date Activated:
04/24/2013

Study Chairs:
L Dawson (NRG), T Mitin (SWOG)

SCHEMA

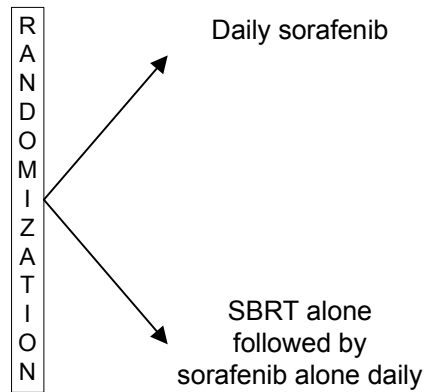

Objectives

To determine if stereotactic body radiation therapy (SBRT) improves overall survival in hepatocellular carcinoma (HCC) patients treated with sorafenib.

To determine the difference in time to progression (TTP) and progression-free survival (PFS) in HCC patients treated with sorafenib compared to SBRT followed by sorafenib.

To measure differences in toxicity in HCC patients treated with sorafenib versus SBRT followed by sorafenib.

To measure vascular thrombosis response post sorafenib versus SBRT followed by sorafenib.

To measure differences in Health Related QOL and quality-adjusted survival in HCC patients treated

with sorafenib compared to SBRT followed by sorafenib.

Patient Population

Patients must have an HCC diagnosis by at least one criterion listed in the protocol within 360 days prior to study entry. Patients must have CT/MRI prior to study entry. Patients must have measureable hepatic disease and/or presence of vascular tumor thrombosis. Patients must have Child-Pugh score A and either intermediate (B) or advanced (C) stage BCLC. Patients must be unsuitable for resection or transplant or radiofrequency ablation (RFA). Patients must be unsuitable for or refractory to transarterial hepatic chemo-embolization (TACE) or drug eluting beads (DEB). Patients must not have any of the following disease characteristics: any one hepatocellular carcinoma greater than 15 cm; total maximal sum of hepatocellular carcinomas or a single conglomerate HCC greater than 20 cm; more

than five discrete intrahepatic parenchymal foci of HCC; direct tumor extension into the stomach, duodenum, small bowel or large bowel; measurable common or main branch biliary duct involvement with HCC; extrahepatic metastases or malignant nodes greater than 3 cm, in sum of maximal diameters.

Patients must not have received prior sorafenib for more than 60 days of duration, prior liver transplant, or radiotherapy to the region of the liver that would result in excessive doses to normal tissues due to overlap of radiation therapy fields. Patients must not have received selective internal radiotherapy/hepatic arterial Yttrium therapy. Patients must not be receiving combination anti-retroviral therapy for HIV.

Patients must be at least 18 years of age and have a Zubrod performance status of 0-2. Patients must have adequate hematologic, hepatic, renal, and coagulation function. Patients must not have severe, active co-morbidity as defined in the protocol.

Stratification/Descriptive Factors

Patient randomization will be stratified by the following factors: (1) vascular involvement: IVC/main portal vein/right or left main branch portal vein vs other vascular involvement vs none; (2) hepatitis: B or B and C vs C vs other; (3) site: North American vs non-North American; and (4) HCC volume/liver volume: 10% vs 10-40% vs >40%.

Accrual Goals

This study requires 368 patients to achieve the accrual goal of 320 evaluable patients. Interim analyses will be conducted when 50% and 75% of the expected number of deaths have been observed.

Summary Statement

For the current status of this study, please refer to the Gastrointestinal chapter.